

**CONTRACT DOCUMENTS
AND
SPECIFICATIONS
FOR
PROJECT NO. 2026-MPO C3
NON-ARTERIAL MILL, PATCH & OVERLAY
MAINTENANCE ZONE 6042**

ATTENDANCE AT PRE-BID CONFERENCE IS MANDATORY

PREPARED BY:
City of Tulsa
175 E. 2nd Street, 13th Floor
Tulsa, OK 74103
918-697-1075
Jerry Dailey



PUBLIC WORKS
Engineering

TERRY BALL, DIRECTOR

Account Numbers: 2036N0001Z.Streets.CWNARP.4286.42863200-541106
2436N0002Z.Streets.CWNARP.410.4103200-541106

Public Works Department
175 East 2nd Street, Suite 261
Tulsa, Oklahoma 74103
(918) 596-9637

CONTRACT DOCUMENTS

PUBLIC WORKS ENGINEERING SERVICES
PROJECT NO. 2026 MPO C3
NON-ARTERIAL MILL, PATCH & OVERLAY MZ 6042

<u>INDEX TO BIDDING DOCUMENTS</u>	<u>PAGE</u>
NOTICE TO BIDDERS	NTB-1-3
INSTRUCTION TO BIDDERS	IB-1-6
RESOLUTION 18145 PROVIDING FOR THE EMPLOYMENT OF RESIDENTS OF THE METROPOLITAN STATISTICAL AREA	R-1-3
SBE UTILIZATION INSTRUCTIONS	UI-1-13
AFFIDAVIT FOR SBE UTILIZATION GOALS	SBE-1-5
RESOLUTION NO. 7404 AFFIDAVIT OF COMPLIANCE	RAC-1
AFFIDAVIT FOR 50% RESIDENT RESOLUTION	RRA-1
NONCOLLUSION AFFIDAVIT	NA-1
BUSINESS RELATIONSHIP AFFIDAVIT	BR-1
INTEREST AFFIDAVIT	IA-1
PROPOSAL	P-1-4
CERTIFICATE OF SECRETARY	CS-1
CONSENT OF MEMBERS	CM-1
SALES TAX EXEMPTION DOCUMENT	STED-1
EXTENSION OF TIME REQUEST	ETR-1
CONTRACT	C-1-4
ESCALATION PROCESS	EP-1
PERFORMANCE BOND	PB-1-2
STATUTORY BOND	SB-1-2
MAINTENANCE BOND	MB-1-2
AFFIDAVIT FOR CONTRACT/CLAIM	AC-1
GENERAL CONDITIONS	GC-1-15
<u>SPECIFICATIONS</u>	
OKLAHOMA DEPARTMENT OF TRANSPORTATION STANDARD SPECIFICATIONS FOR HIGHWAY CONSTRUCTION, 2019 EDITION ORDINANCE #24616	1-19
CITY OF TULSA ENGINEERING SERVICES CONSTRUCTION SPECIFICATIONS – March 2022	

SPECIAL PROVISIONS

SUPPLEMENTAL CONTRACT REQUIREMENTS	SCR-1
INSURANCE REQUIREMENTS	IR-1
SPECIAL PROVISIONS GENERAL	G-1-4
TIME FOR COMPLETION	TC-1-3
ADJUSTMENT FOR ROADWAY UTILITIES	ARU-1-3
COLD MILLING BITUMINOUS PAVEMENT	CMBP-1-2
HIGH EARLY STRENGTH CONCRETE	HESC-1-2
HOT MIX ASPHALT	HMA-1
MINIMUM ASPHALT RETAINED STRENGTH	MARS-1
OWNER ALLOWANCE	OA-1
PATCHING OF CONCRETE AND ASPHALT STREETS	PCAS-1-4
PRICE ADJUSTMENT FOR ASPHALT BINDER	PAFAB-1-3
PAVING OPERATIONS	PO-1
REMOVAL OF CASTINGS	RC-1
UTILITY RELOCATIONS AND DESIGN ISSUES	URDI-1
URBAN RIGHT OF WAY RESTORATION	URWR-1-4
CROSS STREET DRAIN	CSD-1
CONCRETE DRIVEWAY DETAILS	CDD-1-3
PAY ITEM NOTES	PIN-1-6
MULTI-AXIAL COMPOSITE PAVING GRID	MCPG-1-7
GENERAL CONSTRUCTION NOTES	GCN-1-7
PAY QUANTITIES	PQ-1
PROJECT LOCATION	PL-1

Published in the Tulsa World:
February 20, 23, 24,25, 26 and 27, 2025.

**NOTICE TO BIDDERS
SEALED BIDS FOR
PROJECT NO. 2026-MPO C3**

Notice is hereby given that pursuant to an order by the Mayor of the City of Tulsa, Oklahoma, sealed bids will be received in Room 260 of the Office of the City Clerk, City of Tulsa, 175 E. 2nd Street, Tulsa, Oklahoma 74103 until **8:30 a.m. the 27th day of March, 2026** for furnishing all tools, materials and labor and performing the work necessary to be done in the construction of the following:

PROJECT NO. 2026-MPO C3 NON-ARTERIAL MILL, PATCH & OVERLAY MAINTENANCE ZONE 6042

The entire cost of the improvement shall be paid from Account No.

2036N0001Z.Streets.CWNARP.4286.42863200-541106

2436N0002Z.Streets.CWNARP.410.4103200-541106

A **MANDATORY** Pre-Bid Conference is scheduled for **Tuesday, March 3, 2026 at 9:00 a.m.** and will be held through video conferencing with Microsoft Teams, invitation presented on the City of Tulsa's website at this link:

<https://www.cityoftulsa.org/government/departments/engineering-services/construction-bids/>

Attendance at the Pre-Bid Conference is MANDATORY. Bids will not be received from contractors who did not attend the Pre-Bid Conference.

Bids will be accepted by the City Clerk from the holders of valid pre-qualifications certificates from the City of Tulsa in one or more of the following classifications: **A or C.**

Drawings, specifications and contract documents for construction of said public improvements of the said project have been adopted by the Mayor of said City. Copies of same may be obtained at the Office of Contract Administration, 175 E. 2nd St., 13th Floor, Tulsa, OK 74103 for a non-refundable fee in the amount of **\$50.00** made payable to the City of Tulsa by check or money order.

Contract requirements shall include compliance as required by law pertaining to the practice of non-discrimination in employment.

The overall aspirational Small Business Enterprise utilization goal for this project is **ten (10)** percent.

Attention is called to Resolution No. 18145 of August 23, 1988, requiring bidders to commit to the goal of employing on the project at least fifty percent bona fide residents of the City of Tulsa and/or MSA in each employment classification.

Attention is called to Resolution 7404 of November 8, 2006, requiring bidders, their subcontractors and their lower-tier subcontractors to hire only citizens of the United States.

The City of Tulsa itself is exempt from the payment of any sales or use taxes, and pursuant to Title 68 O.S. Section 1356(10), direct vendors to the City are also exempt from those taxes. A bidder may exclude from his bid appropriate sales taxes, which he will not have to pay while acting for and on behalf of the City of Tulsa.

A Certified or Cashier's Check or Bidders Surety Bond, in the sum of 5% of the amount of the bid will be required from each bidder to be retained as liquidated damages in the event the successful bidder fails, neglects or refuses to enter into said contract for the construction of said public improvements for said project and furnish the necessary bonds within thirty days from and after the date the award is made.

The bidder to whom a contract is awarded will be required to furnish public liability and workmen's compensation insurance; Performance, Statutory, and Maintenance bonds acceptable to the City of Tulsa, in conformity with the requirements of the proposed contract documents. The Performance, Statutory, and Maintenance bonds shall be for one hundred percent (100%) of the contract price.

The bidding for this project is subject to a local preference law as defined in Oklahoma Statutes, Title 61, Section 103. For purposes of Section 103 a "local bid" means a bid submitted by a business entity that is authorized to do business in the State of Oklahoma and maintains its primary office or principal place of business within the State of Oklahoma. If the conditions outlined in Title 61 are met, The City of Tulsa must select the second lowest bid if within 5% of the lowest bid and the second lowest bid is a local bid and the lowest bid is not a local bid (i.e. non-local/out of state). Accordingly, when the local bid is required to be selected under the State law, the local bidder must agree to do the work at the lowest bid price to be awarded the project.

All bids will be opened and considered by the Bid Committee of said City at a meeting of said Committee to be held in the City Council Room of City Hall in said City at 9:00 a.m. on the 27th day of March, 2026.

Dated at Tulsa, Oklahoma, this 20th day of February, 2026.

(SEAL)

Christina Chappell
City Clerk

INSTRUCTIONS TO BIDDERS

B-1. BIDS

Each bid Proposal shall be completed, signed, and submitted. No alterations, additions, or erasures shall be made on the Proposal. Erroneous entries shall be lined out, initialed by the bidder, and the correct entry inserted. The unit price bid must cover all expense for furnishing the labor, materials, tools, equipment, and apparatus of every description to construct, erect, and furnish all work required by and in conformance with the Drawings and Specifications.

Each bid shall be enclosed in a sealed envelope addressed to the City of Tulsa, 175 E. 2nd Street, Room 260, City Hall, Tulsa, Oklahoma, identified on the outside with the words:

PROJECT NO. 2026-MPO C3 NON-ARTERIAL MILL, PATCH & OVERLAY MAINTENANCE ZONE 6042

Pre-qualification Certificate Number _____,

And shall be filed with the City Clerk in Room 260, City Hall.

All addenda to the contract documents should be denoted on the last page of the Proposal in the space provided.

B-2. BID SECURITY

Each bid shall be accompanied by a cashier's check, a certified check, or bidder's bond, in the amount of five percent (5%) of the total amount bid.

The bid security shall be made payable, without condition, to the City of Tulsa, Oklahoma. The bid security may be retained by and shall be forfeited to the City as liquidated damages if the bid is accepted, a contract based thereon is awarded, and the bidder fails to enter into a contract in the form prescribed, with legally responsible sureties, within thirty (30) days after such award is made by the City.

B-3 RETURN OF BID SECURITY

The bid security of each unsuccessful bidder will be returned when his bid is rejected. The bid security of the bidder to whom the contract is awarded will be returned when he executes a contract and files satisfactory bonds. The bid security of the second lowest responsible bidder may be retained for a period of time not to exceed sixty (60) days pending the execution of the contract and bonds by the successful bidder.

B-4 WITHDRAWAL OF BIDS

No bidder may withdraw his bid for sixty (60) days after the date and hour set for the opening. A bidder may withdraw his bid any time prior to expiration of the

period during which bids may be submitted by making a written request signed in the same manner and by the same person who signed the Proposal.

B-5 REJECTION OF BIDS

Bids received more than ninety-six (96) hours before the time set for opening bids, excluding Saturdays, Sundays, and holidays, as well as bids received after the time set for opening bids, will not be considered and will be returned unopened.

The City of Tulsa reserves the right to reject any and all bids when such rejection is in the best interest of the City of Tulsa. All bids are received subject to this stipulation and the City reserves the right to decide which bidder shall be deemed lowest responsible bidder.

A violation of any of the following provisions by a bidder shall be sufficient reason for rejecting bidder's bid, or shall make any contract between the City of Tulsa and the Contractor that is based on bidder's bid, null and void: divulging the information in said bid before the bids have been opened; submission of a bid which is incomplete, unbalanced, obscure, incorrect, or which has conditional clauses, additions, or irregularities of any kind not in the original proposal form, or which is not in compliance with the Instruction to Bidders and published Notice to Bidders, or which is made in collusion with another bidder. The City shall have the right to waive any immaterial defects or irregularities in any bid received.

B-6 DISQUALIFICATION OF BIDDERS

No contract will be awarded to any person or persons, firm, partnership, company, or corporation which is in arrears to the City upon any debt of contract, or in default as surety or otherwise upon any obligation to the City.

B-7 SIGNATURE OF BIDDERS

Each bid shall be properly signed with the full name of the company or individual submitting the bid, the bidder's address, and the name and title of all persons signing printed below their signature lines. Bids by partnerships shall be signed with the partnership name followed by the signature and title of one of the partners. Bids by corporations shall be signed with the name of the corporation followed by the signature and title of the president, vice president, chairman, or vice chairman of the Board of Directors with attestation by the corporate secretary or assistant corporate secretary. Bids by joint ventures shall be signed by each participant in the joint venture. Bids by limited liability companies shall be signed with the name of the limited liability company followed by the signature and title of the Manager or Managing Member. Bid by limited partnerships shall be signed with the name of the limited partnership followed by the signature of the general partner. Note: The signature requirements listed above are for Oklahoma entities; entities organized in other states must follow the law of the state in which they are organized.

A bid by a person who affixes to his signature the word "President", "Manager", "General Partner", "Agent", or other title, without disclosing the name of the company for which he is signing, may be held to be the bid of the individual signing.

B-8 INTERPRETATION OF CONTRACT DOCUMENTS

If any bidder who contemplates submitting a bid is in doubt as to the true meaning of any part of the drawing, specifications, or other proposed contract documents, bidder may submit to Contract Administration and the Engineer a written request for interpretation thereof. The person submitting the request shall be responsible for its prompt delivery. Interpretation of the proposed contract documents will be made only by addendum. The addendum will be posted on the City of Tulsa website and emailed to all the pre-bid attendees. The City will not be responsible for any other explanations or interpretations of the proposed contract documents.

B-9 LOCAL CONDITIONS AFFECTING WORK

Each bidder shall visit the site of the work and shall completely inform himself relative to construction hazards and procedure, labor, and all other conditions and factors, local and otherwise, which would affect prosecution and completion of the work and its cost. Such considerations shall include the arrangement and condition of existing structures and facilities, the procedure necessary for maintenance of uninterrupted operation of existing structures and facilities, the availability and cost for labor, and facilities for transportation, handling, and storage of materials and equipment. All such factors shall be properly investigated and considered in the preparation of the bid. There will be no subsequent financial adjustment for lack of such prior information.

B-10 TIME OF COMPLETION

The time of completion is an essential part of the contract and it will be necessary for each bidder to satisfy the City of his ability to complete the work within the allowable time set forth in the Bid Form. For all projects that will impact the public, a public meeting is required before any work is done. In this connection, attention is directed to the provisions of the General Conditions and Special Conditions relative to delays, extension of time, and liquidated damages.

B-11 QUALIFICATION OF BIDDERS

No bid will be received and filed by the City Clerk of the City of Tulsa unless the person submitting the bid has been pre-qualified as provided by ordinance, and is the holder of a current certificate of Pre-qualification in force and effect on the date such bid is to be submitted and filed.

B-12 TAXES AND PERMITS

Attention is directed to the requirements of the General Conditions regarding payment of taxes and obtaining permits. Contractor shall comply with all zoning ordinances of the City, as provided in the Tulsa Zoning Code, Title 42 Tulsa Revised Ordinances and conform with all zoning requirements established by the Tulsa Metropolitan Area Planning Commission and the Board of Adjustment.

Contractor can call the Indian Nations Council of Governments (INCOG) at (918) 584-7526, to determine if any zoning requirements must be met.

B-13 OKLAHOMA LEGAL REQUIREMENTS

The Contractor must comply with the Oklahoma Scaffolding Law, 40 Oklahoma Statutes, Sections 174 - 177, which cover erection and use of scaffolds, hoists, cranes, stays, ladders, supports, or other mechanical contrivances.

In accordance with Oklahoma Statutes, Title 68, Section 1701-1707, before commencing any work pursuant to this contract, any nonresident contractor shall give written notice by certified mail, return receipt requested, to the Oklahoma Tax Commission, the Oklahoma Employment Security Commission, the Workers Compensation Court, and the county assessor of each county in which work will be performed. The notices shall comply with the requirements set forth in said statute.

B-14 BONDS

The bidder to whom a contract is awarded will be required to furnish bonds as follows:

- a. Performance Bond – A Performance Bond to the City in an amount equal to one hundred percent (100%) of the Contract price.
- b. Statutory Bond – A Statutory Bond to the State of Oklahoma in an amount equal to one hundred percent (100%) of the contract price.
- c. Maintenance Bond – A Maintenance Bond to the City in an amount equal to one hundred percent (100%) of the contract price.

The bonds shall be executed on the forms included in the contract documents by a surety company authorized to do business in the State of Oklahoma and acceptable as Surety to the City of Tulsa.

Accompanying the bonds shall be a “Power-of-Attorney” authorizing the attorney-in-fact to bind the Surety Company and certified to include the dates of the bonds.

B-15 BOUND COPY OF CONTRACT DOCUMENTS

Bound contract documents are no longer required.

B-16 EQUAL EMPLOYMENT OPPORTUNITY REQUIREMENTS

Each bidder agrees to comply with the terms of Title 5, Chapter 1, Section 111, of the Tulsa Revised Ordinances relating to Non-Discrimination.

B-17 BASIS FOR AWARD OF CONTRACT

The basis for award of a contract shall be the total base bid submitted by the lowest responsible bidder unless otherwise directed in the form of proposal. The City of Tulsa reserves the right to withhold the awarding of a contract for a reasonable period of time from the date of opening of bids. The awarding of a contract upon a successful bid shall give the bidder no right or action or claim against the City of Tulsa upon such contract until the same shall have been reduced to writing and duly signed by the contracting parties. The award of a contract will not be completed until the contract is duly executed and the necessary bonds and insurance approved.

B-18 TIME FOR AWARDING OF CONTRACT

The awarding of a contract to the lowest responsible bidder will be made within thirty (30) days after the opening of bids unless the City of Tulsa by formal recorded action and for good cause shown, provides for a reasonable extension to that period, which extension period shall not in any event exceed fifteen (15) days where only state or local funds are involved, or not to exceed ninety (90) days on any award of contract for the construction of public improvements where funds are utilized which are furnished by an agency of the federal government.

B-19 SAFETY AND HEALTH REGULATIONS

Bidders should note that they are subject to "Safety and Health Regulations for Construction", Chapter XVII of Title 29, CFR, Part 1926 and that compliance, review and enforcement are the responsibility of the U.S. Department of Labor.

The Contractor is fully responsible for the safety of the work site and is expected to train their employees in all applicable safety issues. This should include but not be limited to: trench safety, confined space entry, head protection, etc. In accordance with construction contracts with the City, Authority, Board, or Commission, all applicable Labor and OSHA safety regulations must be followed.

Work sites must be monitored by the Contractor and safety provisions enforced. Contractors are asked to ensure that all employees are properly informed and trained in construction, work site safety.

B-20 VENDORS AND SUBCONTRACTOR IDENTIFICATION

Where Vendor and Subcontractor Identification Questionnaires are included in the bid documents, each bidder shall submit the Questionnaire directly to the Engineer no later than 5:00 p.m. on the first working day following the bid opening. Failure to submit the questionnaire may render the bid unresponsive and not eligible for award. The award of the Contract will be subject to the acceptability of the vendors and subcontractors listed. If an award is made, the vendors and subcontractors listed on the questionnaire shall be used on the project. No changes in the vendor and subcontractor list will be permitted unless prior consent is obtained from the Engineer.

B-21 U.S. ENVIRONMENTAL PROTECTION AGENCY NPDES REQUIREMENTS FOR STORMWATER DISCHARGES

The bidder's attention is directed to U.S. Environmental Protection Agency (EPA) NPDES requirements for stormwater discharges. The Contractor shall be responsible for filing a Notice of Intent and development and implementation of a Stormwater Pollution Prevention Plan (PPP).

B-22 AMERICANS WITH DISABILITIES ACT

The Contractor shall take the necessary actions to ensure its facilities are in compliance with the requirements of the Americans with Disabilities Act (ADA). It is understood that the program of the Contractor is not a program or activity of the City of Tulsa. The Contractor agrees that its program or activity will comply with the requirements of the ADA. Any costs of such compliance will be the responsibility of the Contractor. Under no circumstances will the Contractor conduct any activity, which it deems non-compliant with the ADA.

RESOLUTION NO. 18145

A RESOLUTION REQUIRING THE INCLUSION IN PLANS AND SPECIFICATIONS FOR PUBLIC IMPROVEMENT CONTRACTS OF PROVISIONS PROVIDING FOR THE EMPLOYMENT OF BONA FIDE RESIDENTS OF THE CITY OF TULSA; AND/OR THE MSA; ALSO PROVIDING THAT AT LEAST OF FIFTY PERCENT (50%) OF EACH CLASS OF EMPLOYEES USED ON A PROJECT BE BONA FIDE RESIDENTS OF THE CITY OF TULSA AND/OR THE MSA; THAT THE DIRECTOR OF THE DEPARTMENT OF HUMAN RIGHTS IS CHARGED WITH ENSURING THAT ALL BIDS FOR PUBLIC CONSTRUCTION CONTRACTS COMPLY WITH THIS RESOLUTION; AND DECLARING AN EMERGENCY.

WHEREAS, City of Tulsa, Oklahoma, desires to achieve a goal of full employment.

WHEREAS, it is necessary for the protection of the health, safety and welfare of all residents of the City of Tulsa, Oklahoma, to accomplish this goal.

NOW, THEREFORE, BE IT RESOLVED BY THE BOARD OF COMMISSIONERS OF THE CITY OF TULSA, OKLAHOMA:

SECTION 1. The City of Tulsa is committed to the policy of achieving full employment of its citizens by encouraging the employment of bona fide Tulsa and MSA residents in public improvement contracts.

SECTION 2. Definitions. The definitions of certain terms used in this resolution are as follows:

a. "Bidding Documents" or "Bid" means the bid notice, plans and specifications, bidding form, bidding instructions, special provisions and all other written instruments prepared by or on behalf of an awarding public agency for use by prospective bidders on a public construction contract.

b. (i) "Bona Fide Residents" shall include only those persons who are either registered to vote in the City of Tulsa or who have resided within the city limits for at least six months, or who have purchased a permanent residence within the city limits or who have leased a residence for at least a six month term. Residency may be further determined by a valid Oklahoma driver's license, a current Oklahoma license tag, and a valid Oklahoma automobile inspection sticker. (ii) Bona fide residents of MSA shall include only those persons who are registered to vote in outlying MSA areas or who have resided within the outlying MSA area for at least six months, or who have purchased a permanent residence within the outlying MSA areas or who have leased a residence for at least a six month term. Residency may be further determined by a valid Oklahoma driver's license, a current Oklahoma license tag, and a valid Oklahoma automobile inspection sticker.

c. "Public Construction Contract" or "Contract" means any contract exceeding Seven Thousand Five Hundred Dollars (\$7,500.00) in amount, awarded by the City of Tulsa for the purpose of making any public improvements or constructing any public building or making repairs to the same.

d. "Public Improvement" means any beneficial or valuable change or addition, betterment, enhancement or amelioration of or upon any real property, or interest therein, belonging to the City of Tulsa, intended to enhance its value, beauty or utility or to adapt it to new or further purposes. The term does not include the direct purchase of materials, equipment or supplies by the City of Tulsa.

CITY OF TULSA
FILED
AUG 23 1988
OFFICE OF THE CLERK

e. "MSA". All of the land areas composed of Creek County, Osage County, Rogers County, Tulsa County and Wagoner County.

SECTION 3. Residency Requirements of Contractor's Employees. Every employee and/or agent of the City of Tulsa, Oklahoma, charged or involved with the preparation of plans and specifications for any public improvement funded in whole or in part with funds of the City of Tulsa, is hereby charged to include in said plans and specifications the following provisions which shall be binding upon the successful bidders:

- a. Each bid shall be accompanied by a sworn statement that the bidder is committed to the goal of employing at least 50% bona fide residents of the City of Tulsa and/or the MSA in each classification as determined by the Oklahoma Commissioner of Labor.
- b. The successful bidder will be responsible for having like requirements placed upon any subcontractor.
- c. The successful bidder will submit to the Director or his designated representative of the Department of Human Rights any compliance reports involving the bidder and its subcontractors required by Title 31, Chapter 1, Section 9, of the Tulsa Revised Ordinances. The reports shall include information about the residence of each employee in each laboring and trade class applicable to any City project.

SECTION 4. Unresponsive Bids. The failure to submit the documents required by Section 3 shall render a bid unresponsive. Said documents must be submitted prior to the opening of the bids. The Director of the Department of Human Rights Section of City Development is charged with ensuring that all bids comply with Section 3 prior to the bid opening date.

SECTION 5. Duty of Employees and/or Agents of the City of Tulsa. Any employee and/or agent of the City of Tulsa who fails to include the goals for residency requirements found in Section 3 in the plans and specifications for any public improvement may be subject to disciplinary action, including dismissal.

SECTION 6. Severability. The invalidity of any section, subsection, provision or clause or portion of this chapter, or the invalidity of the application thereof to any person or circumstance shall not affect the validity of the remainder of this chapter or the validity of its application to other persons or circumstances.

SECTION 7. Effect Date. This resolution shall take effect as of July 1, 1988.

SECTION 8. Emergency Clause. That an emergency exists for the preservation of the public peace, health and safety, by reason whereof this resolution shall take effect immediately upon its passage, approval and publication.

PASSED, with the emergency clause ruled upon separately and approved this 23rd day of August, 1988.

APPROVED, this 23rd day of August, 1988.

Rodger Randle



Mayor

ATTEST: Philip W. Wood

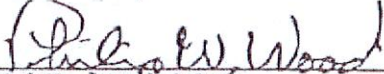

City Auditor

APPROVED: Neal E. McNeil

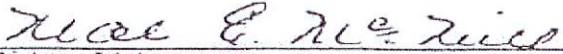

City Attorney

PASSED, with the emergency clause ruled upon
separately and approved this 23 day of August, 1988.
- APPROVED, this 23 day of August, 1988.



Mayor

ATTEST:



City Auditor

APPROVED:



City Attorney

CITY OF YULSA
FILED
AUG 23 1988
A.M. P.M.
Office Of City Auditor
By _____

**CITY OF TULSA, OKLAHOMA
SMALL BUSINESS ENTERPRISE (SBE) UTILIZATION INSTRUCTIONS
BID OPENING AND AWARD SYSTEM**

NOTICE FOR PROJECTS ADVERTISED (effective date 11.03.25)

The “RECIPROCITY” provisions within the City of Tulsa Small Business Enterprise (SBE) Instructions for Oklahoma Department of Transportation (ODOT) DBE firms are suspended until further notice due to changes in federal regulations issued by the USDOT.

Utilization of firms in the ODOT DBE program cannot be counted towards City of Tulsa SBE utilization goals for projects.

ODOT has been issued updated guidance by the USDOT to reassess their DBE programs effective 11.03.25. ODOT’s DBE program is suspended until final rules are established.

CITY OF TULSA, OKLAHOMA SMALL BUSINESS ENTERPRISE (SBE) UTILIZATION INSTRUCTIONS BID OPENING AND AWARD SYSTEM

05.27.25

POLICY STATEMENT

The City of Tulsa (hereinafter City) is committed to implementing the City of Tulsa Small Business Enterprise (SBE) Program of the City of Tulsa, hereinafter referred to as SBE Program. The stated objectives of the programs are:

- To ensure the employment of SBE(s) in the award and administration of City agreements and contracts;
- To create a level playing field on which SBE firms can compete fairly for City contracts;
- To ensure that only firms that fully meet the eligibility standards are permitted to participate as SBE participants;
- To help remove barriers to participation in City contracts;
- To assist in the development of SBE firms so that they may graduate from the SBE Program and ultimately compete successfully in the marketplace.

GOALS BY BUSINESS CATEGORY – SBE

There are seven (7) Business Categories for the City of Tulsa: Construction Contractors (Prime and Subcontractor), Architecture / Engineering (Consultant and Subconsultant), Professional Services, Other Services, and Goods and Supplies. A general description of each category follows:

Construction

- General building contractors engaged primarily in the construction of commercial buildings.
- Heavy construction such as airport runways, bridges, plants, grading and drainage, roadways, and other municipal infrastructure.
- Light maintenance construction services such as carpentry work; electrical work; installation of carpeting; air-conditioning repair, maintenance, and installation; plumbing; and renovation.
- Other related services such as water and sewer lines and maintenance, asbestos abatement, drainage, dredging, grading, hauling, landscaping (for large construction projects such as boulevards and highways), paving, roofing, and toxic waste clean-up.

Architecture and Engineering

- Licensed Architect
- Landscape Architect
- Professional Engineer
- Professional Land Surveyor
- Construction observation
- Other professional design / construction related services

**CITY OF TULSA, OKLAHOMA
SMALL BUSINESS ENTERPRISE (SBE) UTILIZATION INSTRUCTIONS
BID OPENING AND AWARD SYSTEM**

Professional Services

- Financial Services
- Legal services
- Medical services
- Educational services
- Real Estate services
- Planning services.
- Other professional services

Other Services

- Janitorial and maintenance services
- Uniformed guard services
- Computer services
- Certain job shop services
- Graphics, photographic services
- Landscaping
- Other non-technical professional services

Good and Supplies

- Office goods
- Medical supplies
- Miscellaneous building materials
- Computers

The goals are to reflect resource availability and capability. The City of Tulsa's goal is to mitigate and close the disparity between the availability/capability versus actual utilization of SBE firms in Creek, Okmulgee, Osage, Pawnee, Rogers, Tulsa, and Wagoner counties in Oklahoma.

The City enters various agreements and contracts with the private sector for services, goods and supplies, and construction activities. The agreements or contracts may have a specific or primary deliverable associated with one of the Business Categories. However, supplementary efforts may exist to fulfill the agreement or contract. Therefore, the table below is provided to show goals for all Business Categories. Good faith efforts shall first be focused on the Business Category or Categories that relate directly to the deliverables. Additional good faith efforts shall be in supplementary efforts from other categories to assist in meeting the overall project goal.

The project goals will be monitored and periodically adjusted to address the disparity between the available / capable / willing SBE firms versus actual utilization of SBE firms. The **overall project goal is 10%**.

SBE firms identified for utilization in an agreement or contract must be paid from the proceeds from that agreement or contract.

**CITY OF TULSA, OKLAHOMA
SMALL BUSINESS ENTERPRISE (SBE) UTILIZATION INSTRUCTIONS
BID OPENING AND AWARD SYSTEM**

<i>Business Category</i>	<i>SBE Goal (%)</i>
Construction (Prime Contractors)	10
Construction (Subcontractors)	10
Architecture / Engineering (Consultant)	10
Architecture / Engineering (Subconsultant)	10
Professional Services	10
Other Services	10
Goods and Supplies	10

BIDDER'S ACTIONS

For:

- A. **GENERAL / PRIME CONTRACTOR Contract:** When the City has established SBE contract goals (hereinafter referred to as "goals"), the City will award a contract only to a bidder who makes good faith efforts to meet the goals.
- B. **GENERAL / PRIME CONTRACTOR Contract:** When the City has established SBE contract goals (hereinafter referred to as "goals"), a Bidder who is an SBE by membership or reciprocity will be deemed as meeting the utilization goals for the project. Full value of the project bid will be credited as SBE utilization. However, the Bidder who is an SBE is not required to solicit other SBE firms but is encouraged to do so.
- C. **CONSTRUCTION MANAGEMENT AT-RISK (CMAR) Contract:** When the City has established SBE contract goals (hereinafter referred to as "goals"), the City will recommend award to the Construction Management (CM) firm the bidder who makes good faith efforts to meet the goals. However, Bidder(s) who are SBE(s) are not required to solicit other SBE firms but are encouraged to do so.

The following summary outlines the procedures

Summary:

- 1. **RECORD OF SOLICITATION FOR SBE form:**
These forms **MUST** be submitted with the bid documents. These documents establish the initial good faith, outreach efforts. In the event the bidder submitted the lowest bid, the SBE firms identified on these forms submitted with the bid are the only SBE firms that will be considered for establishing the bidder's projected utilization percentages for consideration of the award of bid.
- 2. **LETTER OF INTENT TO CONTRACT WITH SBE form:**
The bidder that submits the apparent lowest bid will be notified by City staff no later than the Monday following bid opening. The apparent low bidder **MUST** submit these forms and the

**CITY OF TULSA, OKLAHOMA
SMALL BUSINESS ENTERPRISE (SBE) UTILIZATION INSTRUCTIONS
BID OPENING AND AWARD SYSTEM**

associated attachments by close of business on Thursday following bid opening. Only SBE firms documented on the RECORD(s) OF SOLICITATION FOR SBE forms submitted with the bid will be considered for establishing the bidder's projected utilization percentages for consideration of the award of bid. If Letters of Intent are not submitted, the projected utilization will be 0% and the apparent lowest bidder is subject to being deemed non-responsive.

3. ADMINISTRATIVE RECONSIDERATION:

If the City determines that a bidder failed to meet the requirements above, City staff will contact the bidder by phone to define the issue and clarify any miscommunications and/or inadvertent actions. If issue was not due to miscommunication and/or inadvertent actions, the bidder will be notified per the Administrative Reconsideration process defined below. If the apparent low bidder is deemed non-responsive, City staff will notify the next lowest bidder to submit their LETTERS OF INTENT TO CONTRACT WITH SBE by close of business of the 6th day following notification or may exercise its right to reject any and all bids.

4. CITY OF TULSA SBE UTILIZATION form:

This form is completed by the contractor (successful bidder) and submitted as part of the contract to perform the project. This form documents the "projected" utilization for the project. At the end of the project, this form is submitted with the final pay request documenting the "actual" utilization. The "actual" utilization must meet or exceed the "projected" utilization. Any change in the "projected" utilization must be documented, submitted to the City on the CHANGE REQUEST FOR SBE PARTICIPATION form, and approved by the City. Approval of the change must occur at the time of the change. If the change is a reduction and not submitted and approved per the instructions, the amount will be deducted from the contractor's final pay request.

5. CHANGE REQUEST FOR SBE PARTICIPATION form:

This form documents any change to the "projected" utilization for the project. Change in utilization includes reduction, substitution, and/or increase. Utilization shall be checked with the submission of partial pay requests, but not longer than 30 day intervals throughout the project. The contractor's acknowledgement that they have verified changes in his/her utilization is required as part of partial pay request documents. Reductions in utilization not approved prior to the final pay request will result in pay reduction to the contractor. If, at the completion of the project, the contractor has failed to meet the SBE contract goals, does not have an approved change request, and has not demonstrated good faith efforts to meet the contract goal, the contractor will be assessed liquidated damages for the difference between the contract goal and the actual SBE participation achieved.

Record of Solicitation

All bidders shall, ***with the submissions of their bids***, show their RECORD(s) OF SOLICITATION FOR SBE that demonstrates the good faith outreach effort to meet or exceed the SBE goals established for the project.

If bidders cannot meet the established SBE goals, the bidders shall document and submit with their bid proposal, justification stating why they could not meet the established SBE goals. To demonstrate

**CITY OF TULSA, OKLAHOMA
SMALL BUSINESS ENTERPRISE (SBE) UTILIZATION INSTRUCTIONS
BID OPENING AND AWARD SYSTEM**

good faith efforts to meet the SBE goals, the bidders shall document their efforts to obtain SBE participation. City will review and determine that the information is complete, accurate and adequately documents the bidder's good faith efforts before committing to the award of the contract to the bidder. In the event that the City awards a contract to a bidder who cannot meet the established SBE goals, the findings of the City's review shall be in written form and shall be incorporated into and become part of the contract documents.

If the bidder to whom City proposes to award the contract is able to demonstrate good faith efforts, City may accept the bidder's proposed goal. Acceptance by the City of the bidder's proposed goal does not release the bidder from its contractual obligation to continue to make efforts throughout the duration of the project to utilize SBE firms on the project.

All bidders shall submit with their bid the completed and signed RECORD OF SOLICITATION FOR SBE form.

Letter of Intent

The bidder must submit to the Engineering Contract Coordinator written confirmation from the SBE firms on the form LETTER OF INTENT TO CONTRACT WITH SBE that it is participating in the contract as provided in the contractor's bid commitment. This may be submitted with the bid, but not later than the City's close of business of the Thursday following the bid opening. The signed forms will define the contractor's final proposed utilization and will be the basis of a final evaluation. If inadequate utilization is proposed, the bid shall be considered non-responsive.

The SBE firms submitted on the LETTER OF INTENT TO CONTRACT WITH SBE forms shall be considered binding and changes of committed SBE firms may only be made after the contract is fully executed, and may only be changed through the submission, review and approval of form CHANGE REQUEST FOR SBE PARTICIPATION.

Failure to make the written assurance (City form LETTER OF INTENT TO CONTRACT WITH SBE), which includes the names of the SBE firms to be used, the work they will perform, and the price for the work, or failure to demonstrate good faith efforts that is deemed acceptable to the City to meet or exceed the SBE goals, shall render a bid non-responsive.

It is the contractor's responsibility to submit the information necessary for the City to ascertain compliance with the good faith efforts requirement. Extra cost involved in finding and utilizing SBE firms shall not be deemed adequate reason for the bidder's failure to meet the project SBE goals unless such costs are grossly excessive.

In instances where a successful bidder's SBE commitment exceeds the actual SBE contract goals, the submitted goals of the bidder become the contractual obligation.

In instances where a successful bidder's SBE commitment is below the SBE contract goals, the submitted utilization goals become the contractual obligation.

**CITY OF TULSA, OKLAHOMA
SMALL BUSINESS ENTERPRISE (SBE) UTILIZATION INSTRUCTIONS
BID OPENING AND AWARD SYSTEM**

Good Faith Efforts

The steps taken by the bidder to obtain SBE participation shall be documented in writing and shall include, but are not limited to, the following good faith efforts:

A. Soliciting through all reasonable and available means (e.g. attendance at pre-bid meetings, advertising and/or written notices) in the interest of all certified SBE firms capable to perform the work of the contract. The bidder must solicit this interest within sufficient time to allow the SBE firms to respond to the solicitation. The bidder must determine with certainty if the SBE firms are interested by taking appropriate steps to follow-up on the initial solicitation.

B. Selecting portions of the work to be performed by SBE firms in order to increase the likelihood that the SBE goals will be achieved. This includes, where appropriate, breaking out contract work items into economically feasible units to facilitate SBE participation, even when the contractor might otherwise prefer to perform these work items with its own forces.

C. Providing interested SBE firms with adequate information about the plans, specifications and requirements of the contract in a timely manner to assist them in responding to a solicitation.

D. Negotiating in good faith with interested SBE firms:

(1) It is the bidder's responsibility to make a portion of the work available to SBE subcontractors and suppliers and to select those portions of the work or material needs consistent with the available SBE subcontractors and suppliers, to facilitate SBE participation. Evidence of such negotiation includes the names, addresses, and telephone numbers of SBE firms that were considered; a description of the information provided regarding the plans and specifications for the work selected for subcontracting; and evidence as to why additional agreements could not be reached for SBE firms to perform the work. RECORD OF SOLICITATION FOR SBE form will be submitted.

(2) A bidder using good business judgment would consider a number of factors in negotiating with subcontractors, including available SBE subcontractors, and would take a firm's price and capabilities as well as contract goals into consideration. However, the fact that there may be some additional costs involved in finding and using SBE firms is not sufficient justification for a bidder's failure to meet the contract SBE goals, as long as such costs are reasonable. Also, the ability or desire of a contractor to perform the work of a contract with its own organization does not relieve the bidder of the responsibility to make good faith efforts. Contractors are not, however, required to accept higher quotes from SBE firms to fulfill the SBE contract requirements if the price difference is excessive or unreasonable. Documentation of quotes shall be submitted to the City with the bid as part of the bidder's record of solicitation.

E. Thoroughly analyzing the capabilities of SBE firms before determining a firm's qualification for a project. The following shall not be legitimate causes for the rejection or non-solicitation of SBE quotes in the efforts of the contractor to meet the project goal: (1) the subcontractor's standing, unrelated to

**CITY OF TULSA, OKLAHOMA
SMALL BUSINESS ENTERPRISE (SBE) UTILIZATION INSTRUCTIONS
BID OPENING AND AWARD SYSTEM**

job performance, within the industry; (2) membership in specific groups or organizations; or, (3) association with certain political and/or social organizations.

Administrative Reconsideration

If City determines that a bidder fails to meet the requirements stated above, the bidder will be provided an opportunity for administrative reconsideration. City staff will contact the bidder by phone to define the issue and clarify any miscommunications or inadvertent actions. If issue was not due to miscommunication and/or inadvertent actions, the following process will be followed:

1. The bidder will be notified by fax/email within ten working days following the bid opening.
2. The bidder will have 2 working days from time of notification to schedule a meeting for the purpose of administrative reconsideration with a City of Tulsa Attorney. Reconsideration meetings will generally be held within 7 days of notification of a bidder being determined non-responsive.

As part of this administrative reconsideration, the bidder will have the opportunity to meet in person with a City of Tulsa Attorney to present arguments concerning whether it met the goal or made adequate good faith efforts to do so. Submittal of additional information documenting solicitation, which was due with the original bid submission, will not be accepted or considered.

3. The decision on reconsideration will be made by a City of Tulsa Attorney who did not take part in the original determination that the bidder failed to meet the goal or make adequate good faith efforts to do so.
4. No awards will be made until all administrative reconsiderations as outlined herein are complete. A City of Tulsa Attorney will provide a written decision on reconsideration to the bidder. This decision will explain the basis for finding that the bidder did or did not meet the goal or make adequate good faith efforts to do so. The determination is copied to the Contract Administrator, City Engineer, and the Director of Human Rights.

CONTRACTOR ACTIONS AFTER AWARD OF THE CONTRACT:

Counting SBE Participation Toward the Goal

When an SBE participates in a contract, only the value of the work actually performed by the SBE is counted toward the contract goal.

The entire amount of that portion of a contract that is performed by the SBE firm's own forces is counted, including the cost of supplies and materials obtained by the SBE for the work on the contract, including supplies purchased or equipment leased by the SBE (except supplies and equipment the SBE purchases or leases from their Prime Contractor).

CITY OF TULSA, OKLAHOMA SMALL BUSINESS ENTERPRISE (SBE) UTILIZATION INSTRUCTIONS BID OPENING AND AWARD SYSTEM

When an SBE performs as a participant in a joint venture, the portion of the total dollar value of the contract is equal to the clearly defined portion of the work that the SBE performs with its own forces may be counted toward the goal.

Only expenditures to an SBE contractor who performs a commercially useful function may be counted toward an SBE goal.

Commercially Useful Function

An SBE performs a commercially useful function when it is responsible for the execution of the work of its contract and is carrying out its responsibilities by actually performing, managing and supervising the work involved. The SBE must be responsible, with respect to materials and supplies used on the contract, for negotiating price, determining quality and quantity, ordering the material, and installing (where applicable) and paying for the material itself.

To determine whether an SBE is performing a commercially useful function, City will evaluate the amount of work subcontracted, industry practices, whether the amount the firm is to be paid is commensurate with the work it is actually performing and the SBE credit claimed, and other relevant factors.

An SBE does not perform a commercially useful function if its role is limited to that of an extra participant in a transaction through which funds are passed in order to obtain the appearance of SBE participation. In determining whether an SBE is acting as a pass-through, City will examine similar transactions, particularly those in which SBE firms do not participate.

Manufacturers and Material Suppliers

If the materials or supplies are obtained from a certified SBE manufacturer, 100 percent of the cost of the materials or supplies will be counted toward the SBE goals. A manufacturer is a firm that operates or maintains a factory or establishment that produces, on the premises, the materials required under the contract as described by the specifications.

If the materials or supplies are purchased from a certified SBE regular dealer, 100 percent of the cost of the materials or supplies will be counted toward the SBE goals. A regular dealer is a firm that owns, operates or maintains a store, warehouse, or other establishment in which the materials, supplies, articles, or equipment described by the specification and required under the contract are bought, kept in stock, and regularly sold or leased to the public in the usual course of business.

To be a regular dealer, the firm must be an established, regular business that engages, as its principal business and under its own name, in the purchase and sale or lease of the products in question. A person may be a regular dealer in such bulk items as petroleum products, steel, cement, gravel, stone, or asphalt without owning, operating or maintaining a place of business as provided for in the above paragraph if the person both owns and operates distribution equipment for the products. Any supplementing of regular dealers' own distribution equipment shall be by a long-term lease agreement and not on an ad-hoc or contract-by-contract basis.

**CITY OF TULSA, OKLAHOMA
SMALL BUSINESS ENTERPRISE (SBE) UTILIZATION INSTRUCTIONS
BID OPENING AND AWARD SYSTEM**

In order for a firm to qualify as an SBE supplier of metal and/or concrete pipe, the firm must also fabricate the pipe. Metal or concrete pipe is specialty pipe which is project specific and is inspected during the manufacturing process. This arrangement provides for no warehousing of metal or concrete pipe and essentially requires the manufacturer to be the supplier. Merely ordering pipe from the fabricator and in turn selling it to contractors is not consistent with normal industry practice. Contractors normally purchase pipe directly from the manufacturer, thus eliminating the middleman. Supplying metal or concrete pipe is viewed as brokering and is considered inconsistent with SBE program requirements.

Change Request for SBE Participation

Substitution or replacement of an SBE firm will only be permitted or allowed after award and execution of the City contract.

A contractor may not terminate for convenience an SBE listed in their contract (or an approved substitute SBE firm) and then perform the work of the terminated subcontract with its own forces or those of an affiliate, without City's prior written consent.

When an SBE is terminated or fails to complete the work of the contract for any reason, the contractor must make good faith efforts to find another SBE to substitute for the original SBE. These good faith efforts shall be directed at finding another SBE to perform at least the same amount of work (not necessarily the same work) under the contract as the SBE that was terminated, to the extent needed to meet the SBE goals established in the contract.

When the contractor obtains a substitute SBE, the contractor shall provide the Engineering Contract Coordinator with copies of the CHANGE REQUEST FOR SBE PARTICIPATION form and supporting documentation.

If the contractor is unable to replace the SBE with another SBE, then the contractor must provide City with evidence in writing that they have made a good faith effort. The contractor must submit to the Engineering Contract Coordinator a CHANGE REQUEST FOR SBE PARTICIPATION form along with documentation to support they have made a good faith effort. City may adjust the goal as appropriate.

In the case where a contractor cannot meet the SBE goals of a contract, he or she should request a change of that portion of the SBE goal, which cannot be met. The request will be subject to the following:

- A written request for change will be initiated by the contractor at the time he or she reasonably knows that despite good faith efforts the contract goal cannot be achieved. The request will be included on the CHANGE REQUEST FOR SBE PARTICIPATION form and will contain written documentation of all good faith efforts made to meet the goal as well as the reason for the change.

CITY OF TULSA, OKLAHOMA SMALL BUSINESS ENTERPRISE (SBE) UTILIZATION INSTRUCTIONS BID OPENING AND AWARD SYSTEM

- The request for change, CHANGE REQUEST FOR SBE PARTICIPATION form, will be submitted for review to the Engineering Contract Coordinator. The City will make the decision on the approval or denial of the change request and inform the contractor.
- If, at the completion of the project, the contractor has failed to meet the SBE contract goals, does not have an approved change request, and has not demonstrated good faith efforts to meet the contract goal, the contractor will be assessed liquidated damages for the difference between the contract goal and the actual SBE participation achieved. The City shall deduct the liquidated damages from the final payment. In the event insufficient earnings remain for the reduction of liquidated damages, the City may claim against the contractor's bond, suspend the contractor under performance suspension, withhold further proposals, suspend prequalification and/or other remedies available under the law.
- In those instances when the goal is not met due to a change in quantity, which occurs through no fault of the contractor, but due to City and/or changed site conditions, a change request will be recommended by Field Engineering at the time the change becomes known, but not later than the next progressive payment application from the contractor which covers the work identified for the SBE firm. The change request will include the statement of quantity change(s). The contractor shall endeavor, with good faith efforts, to mitigate underruns by utilizing other SBE firms.

Change in utilization includes reduction, substitution, and/or increase. Utilization shall be checked with the submission of each partial pay request, but not longer than 30 day intervals throughout the project. The contractor's acknowledgement that they have verified changes in his/her utilization is required as part of partial pay request documents. Reductions in utilization not approved prior to the final pay request, will result in pay reduction to the contractor.

If a contractor fails to comply with this section, appropriate administrative remedies may be taken including, but not limited to:

- No additional progressive payments may be processed
- Refusal to issue proposals
- Liquidated damages
- Suspension of work on the project
- Suspension of prequalification
- Termination of the contract

Prompt Payments

To ensure that contractors' obligations under City contracts are met, the contractor shall endeavor to pay all subcontractors for satisfactory performance of their contracts no later than fifteen (15) calendar days after receipt of each progressive payment from City. The contractor must further endeavor to make prompt release of retainage held to the SBE within thirty days after the work is satisfactorily completed, whether the contractor's work is complete or not. The term "satisfactorily completed" is defined as when; 1) City finds the work completed in accordance with the Plans and Specifications; 2)

**CITY OF TULSA, OKLAHOMA
SMALL BUSINESS ENTERPRISE (SBE) UTILIZATION INSTRUCTIONS
BID OPENING AND AWARD SYSTEM**

any required paperwork, including material certification, payrolls, etc., have been received and approved by City; 3) Field Engineering has determined the final quantities on the subcontractor's portion of the work; and 4) Contractor has received progressive payments from City which includes subcontractors' work.

In an effort to accelerate payments to subcontractors, the City may pay the Contractor for acceptable material stockpiled or delivered to the project, at other approved or designated locations, or at a plant site required for Contractor's operations as approved by the City. This is governed by Oklahoma Department of Transportation Standard Specifications for Highway Construction 2009 or latest edition.

Contractor shall endeavor to include invoices from SBE for materials on hand, partially completed work, or complete work on the earliest partial payment request submitted to the City. It is incumbent on the SBE to submit invoices to the Contractor in a timely manner.

Failure to comply with the prompt payment and return of retainage provisions of the contract may result in sanctions under the contract, as listed below:

- Refusal to issue proposals
- Liquidated damages
- Suspension of work on the project
- No additional progressive payments may be processed
- Suspension of prequalification

Any delay or postponement of payment among the parties may take place only for good cause, with City written approval. The explanation from the contractor must be made in writing to the City.

Record Keeping Requirements

The contractor shall keep such records as are necessary to determine compliance with the SBE contract obligations. The records kept by the contractor will indicate:

1. The name(s) of SBE firms or other subcontractors, the type of work being performed, and payment for work, services and business.
2. Documentation of correspondence, verbal contracts, telephone calls, etc., to obtain services of SBE firms on the project.

Upon request, the contractor shall submit all subcontracts, purchase orders, contracts, agreements, and financial transactions, including canceled checks, executed with SBE firms with the reference to records referred to in this provision, in such form, manner, content prescribed by City.

The contractor should list all SBE firms in the contract and summarize total amounts paid to SBE firms and the project goal amount for each SBE firm.

**CITY OF TULSA, OKLAHOMA
SMALL BUSINESS ENTERPRISE (SBE) UTILIZATION INSTRUCTIONS
BID OPENING AND AWARD SYSTEM**

Reciprocity

~~The City will grant reciprocity of membership in the SBE program to certified Oklahoma Department of Transportation Disadvantaged Business Enterprises which are located in the Tulsa Metropolitan Statistical Area.~~

(Must be submitted with Bid)

**CITY OF TULSA
BIDDER'S AFFIDAVIT FOR
SMALL BUSINESS ENTERPRISE (SBE) UTILIZATION GOALS**

STATE OF)
) ss:
COUNTY OF)

_____, of lawful age, being first duly sworn, says that s(he) is the agent authorized by the bidder to submit the attached bid. Affiant further states that the bidder agrees to fully comply with the City of Tulsa's Resolution requiring that a good faith effort be made to utilize small business enterprises as subcontractors.

Affiant further states that s(he) will document on pages SBE-2BID, -3BID, -4BID, and -5BID for public record, his/her good faith efforts in solicitation.

Affiant further states that s(he) is responsible for having like requirements placed upon any subcontractor of said bidder.

Affiant further states that s(he) has read and agrees to the current CITY OF TULSA, OKLAHOMA SMALL BUSINESS ENTERPRISE (SBE) UTILIZATION INSTRUCTIONS FOR BID OPENING AND AWARD SYSTEMS.

BIDDER (Company Name)

SIGNED

TITLE

SUBSCRIBED and SWORN to before me this _____ day of _____, 20_____.

NOTARY PUBLIC

MY COMMISSION EXPIRES:

SBE-1BID



RECORD OF SOLICITATION FOR SMALL BUSINESS ENTERPRISE (SBE)
(MUST BE SUBMITTED WITH BID)

- Project Name:	
- Project Number:	
- Prime Contractor:	
- Prime Contractor Representative:	
Consultants, Subcontractors, Service, Regular Dealers, Material Suppliers, & Fabricators:	
- Contact Date(s):	
- Name of Company:	
- Address (Street, City, County, State):	
- City of Tulsa SBE: <input type="checkbox"/> Yes <input type="checkbox"/> No	
- City of Tulsa SBE Certificate Number:	
- Other SBE Certificate Number(s):	
- Company Contact Person:	
- Phone No.:	Email:
- Description of Work:	
- Contract Documents provided to and/or reviewed by Company: <input type="checkbox"/> Yes <input type="checkbox"/> No	
- Will City of Tulsa SBE be utilized? <input type="checkbox"/> Yes <input type="checkbox"/> No	
- If Yes, Estimated Agreement Amount: \$	
- If No, description of reasons why agreement could not be reached for City of Tulsa SBE to perform work:	



LETTER OF INTENT
TO CONTRACT WITH SMALL BUSINESS ENTERPRISE (SBE)
(Must be submitted by close of business on Thursday following bid opening)

Public Works Department, Attn: Contracts Coordinator
CITY OF TULSA
175 E. 2nd Street, Floor 13
Tulsa, OK 74103
Ph.: 918.596.9637
Fax: 918.596.1299

Project Name: _____
Project Number: _____
Submittal Date: _____

Prime Contractor

HEREBY, intends to subcontract items of work generally described as

to:

SMALL BUSINESS ENTERPRISE

Total amount of participation by City of Tulsa SBE: \$ _____
(City of Tulsa SBE, quote must be attached)

City of Tulsa SBE: Yes No

City of Tulsa SBE Certificate Number: _____

Other SBE Certificate Number(s): _____

SMALL BUSINESS ENTERPRISE

PRIME CONTRACTOR

Signature: _____

Signature: _____

Title: _____

Title: _____

Date: _____

Date: _____

Signatures of Authorized representatives of the Prime Contractor and the City of Tulsa SBE firm above represent the written commitment by the Prime Contractor to subcontract with the City of Tulsa SBE firm and a written commitment by the City of Tulsa SBE firm to subcontract for work as described in the attached quote.

This form, along with the City of Tulsa SBE firm's quote must be submitted to the City with the executed Contract documents. If this form is not received, the proposed utilization will NOT be counted as part of the Prime Contractor's agreement. This may cause the agreement to be considered non-compliant and be rejected by the City of Tulsa.

SBE – 3BID



CHANGE REQUEST
FOR SMALL BUSINESS ENTERPRISE (SBE) PARTICIPATION

Project Name: _____

Project Number: _____

Prime Contractor: _____

CHANGE: From / To (fill in both sides)
FROM:

OR

ADD: To (fill in this side only)
TO:

Name: _____

Name: _____

City of Tulsa SBE: Yes No
City of Tulsa SBE Certificate Number: _____
Other SBE Certificate Number(s): _____

City of Tulsa SBE: Yes No
City of Tulsa SBE Certificate Number: _____
Other SBE Certificate Number(s): _____

Change in service to be performed: _____

Change in amount of participation by City of Tulsa SBE: \$ _____

Reason for Change: _____

NOTE: Attach a copy of the Letter of Intent for the original City of Tulsa SBE and a new Letter of Intent for the proposed City of Tulsa SBE.

PRIME CONTRACTOR

SBE SUBCONTRACTOR

Signature: _____

Signature: _____

Date: _____

Date: _____

Title: _____

Title: _____

Approved / Disapproved: _____ Date: _____

Public Works Design Engineering Manager
(Planning, Design, or Field)

Approved / Disapproved: _____ Date: _____

Public Works Contracts Coordinator

Distribution: Tulsa Authority for Economic Opportunity
Public Works Design/Public Works Department (Planning, Design, or Field)



CITY OF TULSA
SMALL BUSINESS ENTERPRISE (SBE) UTILIZATION

Project No.		Contractor
Project Name		

Name	Business Category	Projected Dollars	Actual Dollars

Projected Contract % _____ **Actual Contract %** _____ **Total** _____

PROJECTED: _____ **ACTUAL (Update and Submit with Final Payment):**

Contractor Representative _____ Contractor Representative _____
Date _____ Date _____

NOTE: REFER TO UTILIZATION INSTRUCTIONS

(Must be submitted at time of Bid)
CITY OF TULSA
RESOLUTION NO. 7404
AFFIDAVIT OF COMPLIANCE

_____, of lawful age, being first duly sworn, states that s(he) is the authorized agent of the Company set forth below.

Affiant further states that the Company, in compliance with City of Tulsa Resolution No. 7404, shall not hire or knowingly allow any of its subcontractors or lower tier subcontractors to hire anyone who is not a United States citizen or legal immigrant or anyone who does not have legal status as a temporary worker to perform work on any project which is the subject of a contract between the Company and the City of Tulsa.

Affiant further states that the Company shall not fail to comply with and shall not knowingly allow any of its subcontractors or lower tier subcontractors to fail to comply with all applicable laws including, but not limited to, labor, employment and taxation laws, in the performance of any work on any project which is the subject of a contract between the Company and the City of Tulsa.

Affiant further states that the Company shall make available to the City of Tulsa, at the City's request, sufficient information and/or affirmations to allow the City to confirm Company's compliance with Resolution No. 7404 relating to the performance of any contract between the Company and the City of Tulsa.

Company: _____

Signed: _____

Title

SUBSCRIBED and SWORN to before me, this ____ day of _____, 20__.

NOTARY PUBLIC

MY COMMISSION EXPIRES:

COMMISSION NO.:

Resolution No. 7404
RAC-1

(Must be submitted at time of Bid)
CITY OF TULSA
50% RESIDENT RESOLUTION
AFFIDAVIT FOR BID

STATE OF)
) ss:
COUNTY OF)

_____, of lawful age, being first duly sworn, states that s(he) is the agent authorized by the bidder to submit the attached bid. Affiant further states that the bidder, in compliance with City of Tulsa Resolution No. 18145, is committed to the goal of employing at least 50% bona fide residents of the City of Tulsa and/or the Metropolitan Statistical Area (composed of Creek, Okmulgee, Osage, Pawnee, Rogers, Tulsa, and Wagoner counties).

Affiant further states that bidder is responsible for having like requirements placed upon any of its subcontractors.

BIDDER (Company Name)

SIGNED

Title

SUBSCRIBED and SWORN to before me this ____ day of _____, 20__.

NOTARY PUBLIC

MY COMISSION EXPIRES:

COMMISSION NO.:

(Must be submitted at time of bid)
BUSINESS RELATIONSHIP AFFIDAVIT

STATE OF)
) ss:
COUNTY OF)

_____, of lawful age, being first duly sworn, says that s(he) is the agent authorized by the bidder to submit the attached bid. Affiant further states that the nature of any partnership, joint venture or other business relationship presently in effect or which existed within one (1) year prior to the date of this statement with the architect, engineer, or other party to the project is as follows:

Affiant further states that any such business relationship presently in effect or which existed within one (1) year prior to the date of this statement between any officer or director of the bidding company and any officer or director of the architectural or engineering firm or other party to the project is as follows:

Affiant further states that the names of all persons having any such business relationships and the positions they hold with their respective companies or firms are as follows:

(If none of the business relationships herein above mentioned exist, affiant should so state.)

Signed: _____

BIDDER (Company Name)

Title:

SUBSCRIBED and SWORN to before me this _____ day of _____, 20__.

NOTARY PUBLIC

MY COMMISSION EXPIRES:

_____, _____
COMMISSION NO.:

(Must be submitted at time of bid)
INTEREST AFFIDAVIT

STATE OF _____)
)ss.
COUNTY OF _____)

I, _____, of lawful age, being first duly sworn, state that I am the agent authorized by Contractor, Engineer, Architect or provider of professional service ["Services Provider"] to submit the attached Agreement. Affiant further states that no officer or employee of the City of Tulsa either directly or indirectly owns a five percent (5%) interest or more in the Services Provider's business or such a percentage that constitutes a controlling interest. Affiant further states that the following officers and/or employees of the City of Tulsa own an interest in the Services Provider's business which is less than a controlling interest, either direct or indirect.

By _____
Signature

Title _____

Subscribed and sworn to before me this ____ day of _____, 20__.

Notary Public

My Commission Expires: _____

Notary Commission Number: _____

County & State Where Notarized: _____

The Affidavit must be signed by an authorized agent and notarized.

ELECTRONIC BID PROPOSAL INSTRUCTIONS - EXCEL SPREADSHEET
PROJECT NO.2026 MPO C3 NON-ARTERIAL MILL PATCH & OVERLAY

Please read the following instructions carefully.

1. After opening this file re-save it as your company's name.
2. Open the BID FORM Sheet from the tabs below.
3. Input the unit price of the appropriate pay item in the cells highlighted in blue.
4. Review all data input and check calculations to ensure accuracy of Bid.
5. Print 1hardcopy of the "PROPOSAL" tab, BID FORM and the "SIGNATURE PAGE" tab.
6. Complete and sign the "Signature Page" document.
6. Submit hardcopy and electronic disk with Contract Documents and Specifications for Bid opening date.

AGREEMENT FOR USING ELECTRONIC BID PROPOSAL

By and Between: City of Tulsa, (ENGINEER) and RECIPIENT. The enclosed electronic media is provided pursuant to your request and is for your limited use in connection with your submittal of Bid Proposal for Project No. 2026 MPO C3 NON-ARTERIAL MILL, PATCH & OVERLAY MZONE 6035. In no event shall the information be used for any other purpose or be released to third parties without the written consent of the ENGINEER. In the event of a discrepancy between the hard copy and this electronic media at delivery or in the future, the hard copy shall govern. ENGINEER hereby disclaims any and all liability for the consequences from use of the electronic media and makes no warranty or guarantee of accuracy. RECIPIENT shall assume full responsibility for the uses and consequences of the electronic media. It is agreed that ENGINEER has and retains ownership of the electronic media. ENGINEER does not warrant or guarantee that the electronic data is compatible with RECIPIENT'S computer hardware or software, and ENGINEER'S responsibility for the electronic media is limited to replacement of defective media for a period of thirty (30) days after delivery to RECIPIENT!!! By opening and using this FILE, You AGREE to these TERMS AND CONDITIONS!!!

**PROPOSAL FOR
PROJECT NO. 2026 MPO C3
NON-ARTERIAL MILL, PATCH, & OVERLAY**

TO: HONORABLE MAYOR
CITY OF TULSA, OKLAHOMA

THE UNDERSIGNED BIDDER, having carefully examined the drawings, specifications, and other Contract Documents of the above project presently on file in the City Clerk, City of Tulsa Oklahoma:

CERTIFIES THAT he has inspected the site of the proposed work and has full knowledge of the extent and character of the work involved, construction difficulties that may be encountered, and materials necessary for construction, class and type of excavation, and all other factors affecting or which may be affected by the specified work; and

CERTIFIES THAT he has not entered into collusion with any other bidder or prospective bidder relative to the project and/or bid: and

HEREBY PROPOSES: to enter into a contract to provide all necessary labor, materials, equipment and tools to completely construct and finish all the work required by the Contract Documents referred to therein; to complete said work within 120 calendar days after the work order is issued; and to accept in full payment therefore the amount set forth below for all work actually performed as computed by the Engineers as set forth in the Contract.

Basis of Award

IT SHOULD BE NOTED THAT THE LOWEST RESPONSIBLE BID SHALL BE DETERMINED BY THE TOTAL BASE BID.

Note: - Item numbers omitted are not a part of the Contract.

PROPOSAL FOR
PROJECT NO. 2026 MPO C3

ITEM NUMBER	SPEC NUMBER	ITEM DESCRIPTION	UNIT	QUANTITY	DATA INPUT UNIT PRICE	AMOUNT
1	202(A)	UNCLASSIFIED EXCAVATION	CY	800		
2	230(A)	SOLID SLAB SODDING	SY	500		
3	303(A)	AGGREGATE BASE TYPE A	CY	800		
4	310(B)	SUBGRADE METHOD B	SY	500		
5	325	SEPARATOR FABRIC	SY	900		
6	409	FABRIC REINFORCEMENT(GP-25)	SY	45,000		
7	411(S4)	ASPHALT CONCRETE, TYPE S4 (PG 64-22) (2"THICKNESS)	TON	5,000		
8	411(D)	TYPE "S5" ASPHALT CONCRETE (LEVEL UP 1")	TON	1		
9	412	COLD MILLING PAVEMENT (2" THICKNESS)	SY	45,000		
10	609(A)	REMOVE AND REPLACE 6" CONCRETE CURB	LF	1		
11	609(B)	REMOVE AND REPLACE 6" CONCRETE CURB AND GUTTER	LF	500		
12	610(A)	4" CONCRETE SIDEWALK	SY	3,400		
13	610(B)	REMOVE AND REPLACE 6" HES PCC DRIVEWAY	SY	2,200		
14	610(SP)	CURB RAMP	EA	10		
15	610(I)	TACTILE WARNING DEVICE	SF	90		
16	612(A)	ADJUST MANHOLE TO GRADE	EA	10		
17	612(C)	ADJUST INLETS TO GRADE	EA	10		
18	612(E)	ADJUST VALVE BOXES TO GRADE	EA	10		
19	619(B)	REMOVAL OF SIDEWALK	SY	3,400		
20	641	MOBILIZATION	EA	1		
21	855(A)	TRAFFIC STRIPE(PLASTIC)(4"WIDE)	LF	1		
22	855(B)	TRAFFIC STRIPE(PLASTIC)(ARROW)	EA	1		
23	855(B)	BIKE LANE SYMBOL(GREEN BACKGROUND)(PRE-FORMED)	EA	1		
24	855(B)	BICYCLE SYMBOL WITH SHARROW(WHITE)	EA	1		
25	855(B)	BICYCLE SYMBOL(NO SHARROW)(WHITE)	EA	1		
26	COT 202	QUICK SET FLOWABLE FILL	CY	5		
27	COT 335	CONTRACTOR'S QUALITY CONTROL	LSUM	1		
28	SPECIAL	TRAFFIC CONTROL	LSUM	1		
29	SPECIAL	PRE-FORMED BIKE LANE MARKINGS (24"WIDE)(BLM-1)	LF	1		
30	SPECIAL	JOINT SEAL(SILICONE)	LF	10		
31	SPECIAL	TYPE I AC PATCH WITH TYPE S3 (PG 64-22 OK)	CY	65		
32	SPECIAL	TYPE I PCC PATCH	CY	10		
33	SPECIAL	URBAN RIGHT OF WAY RESTORATION	EA	1		
34	SPECIAL	CROSS-STREET DRAINS HES PCC	CY	5		
35	SPECIAL	MULTI-AXIAL COMPOSITE PAVING GRID (MCPG-1-7)	SY	1		
36	SPECIAL	OWNER ALLOWANCE	ALLOW	10,000	\$1.00	\$10,000.00
		TOTAL				\$10,000.00

TOTAL BASE BID

\$10,000.00
Figures

Enclosed is a () Bidder's Surety Bond, () Certified Check, () Cashier's Check for

_____ Dollars (\$ _____)
Figures

which the City of Tulsa may retain or recover as liquidated damages in the event that the undersigned fails to enter into contract for the work covered by this proposal., provided the Contract is awarded to the undersigned within thirty (30) days, or within ninety (90) days if Federal funds are utilized, from the date fixed for opening of bids and the undersigned fails to execute said Contract and furnish the required bonds and other requirements as called for in these Contract Documents within thirty (30) days after award of Contract.

Dated at Tulsa, Oklahoma, this _____ day of _____, 20__.

Respectfully submitted,

(Complete legal name of company)

(State of Organization)

By: _____
Title: _____
Printed Name: _____

ATTEST: _____
Title: Corporate Secretary
Printed Name: _____
(SEAL)

Address: _____

Telephone Number: _____

Fax Number: _____

By signing above bidder acknowledges receipt of the following Addenda (give number and date of each):

This form is made available for example purposes only and is not intended to be legal advice nor intended to be relied upon in lieu of consultation with an attorney.

Certificate of Secretary

The undersigned _____ (Assistant) Secretary of _____, a _____ corporation, (the "Corporation") hereby certifies that the following is a true and correct copy of a Resolution duly adopted by the Board of Directors of the Corporation on the _____ day of _____, 20__.

RESOLVED, that _____ is authorized to execute and enter into bids, contracts, bonds, affidavits and any ancillary documents, on behalf of the Corporation.

The undersigned further certifies that this Resolution is in full force and effect as of the date of this Certificate and has not been amended, modified, revoked or rescinded.

IN WITNESS WHEREOF, I have executed this Certificate this ___ day of _____, 20__.

(Signature)

Printed Name

(Assistant) Secretary

This form is made available for example purposes only and is not intended to be legal advice nor intended to be relied upon in lieu of consultation with an attorney.

Consent of Members

The undersigned, being all of the Members of [Name of Company], LLC, an Oklahoma Limited Liability Company, hereby authorize, consent to, approve and ratify the execution by _____ on behalf of [Name of Company], LLC of bid proposals, contracts, affidavits and related documents in connection with [Name of Project] of the City of Tulsa.

DATED, this ____ day of _____, 20__.

Name printed: _____

Name Printed: _____

[ADD ADDITIONAL LINES FOR ADDITIONAL MEMBERS]



PUBLIC WORKS
Engineering

DATE:
Month Day, Year

{Company Name}
(Address)
{City, State Zip}

RE: City of Tulsa Project No. {number and Title}

TO WHOM IT MAY CONCERN:

Please be advised that the City of Tulsa, Oklahoma, a municipal corporation, has contracted for the construction of a public improvement project as referenced above, and that pursuant to Title 68 § Section 1356 (10), sales on tangible personal property or services to be wholly consumed in the performance of such projects are exempt from Oklahoma and City of Tulsa Sales Tax when:

“...Any person making purchases on behalf of such subdivision or agency of the state shall certify, in writing, on the copy of the invoice or sales ticket to be retained by the vendor that the purchases are made for and on behalf of such subdivision or agency of this state and set out the name of such public subdivision or agency.”

This letter of authorization expires **{Date.}**

A photostatic copy of this letter may be considered as the original.

CITY OF TULSA

Paul D. Zachary, P.E.
Deputy Director

cc: Ryan McKaskle

HAS:JR:kt

STED-1

EXTENSION OF TIME REQUEST
(to be submitted with each partial payment application)

DATE: _____

CONTRACTOR: _____

ADDRESS: _____

CONTRACT NO.: _____

PROJECT NO.: _____

DESCRIPTION: _____

ARE THERE ANY CHANGES TO YOUR SBE UTILIZATION? YES NO

IF YES, GIVE REASON AND ATTACH CHANGE REQUEST FORM (SBE-4): _____

EXTENSION OF CONTRACT TIME REQUIRED: YES NO

TOTAL OF EXTENSION TIME REQUESTED: _____

IF YES GIVE REASON: _____

SIGNATURE - CONTRACTOR

CONSULTING ENGINEER OR DEPARTMENT OF PUBLIC WORKS STAFF RECOMMENDATIONS

APPROVED: _____

REJECTED: _____

REASON: _____

SIGNATURE

DATE

ACTION WILL BE TAKEN WITHIN 30 DAYS FROM RECEIPT OF REQUEST

ETR-1

**CONTRACT FOR CONSTRUCTION OF PUBLIC IMPROVEMENTS
TULSA, OKLAHOMA**

THIS CONTRACT made and entered into the ____ day of _____, 2026, by and between ___an (list state)_____ (Corporation or Limited Liability Company) of _____, Oklahoma, hereinafter called the "CONTRACTOR", and the CITY OF TULSA - TULSA, OKLAHOMA, a Municipal Corporation, herein called the "CITY."

WITNESSETH:

WHEREAS, the City has caused to be prepared the necessary Drawings, Specifications, and other Contract Documents for the public improvements herein described, and has invited bids for the construction thereof in accordance with the terms of this Contract, all of which is hereby designated as:

**PROJECT NO. 2026-MPO C3 NON-ARTERIAL MILL, PATCH & OVERLAY
MAINTENANCE ZONE 6042**

WHEREAS, the Contractor, in response to the Advertisement, has submitted to the City, in the manner and at the time specified, a sealed bid in accordance with the terms of this Contract; and,

WHEREAS, the City, in the manner prescribed by law, has publicly opened, examined, and canvassed the bids submitted, and has determined the above named Contractor to be the lowest responsible bidder for the work and has duly awarded to the said Contractor therefore, for the sum or sums named in the Contractor's bid, a copy of the Bid Form being attached to and made a part of this Contract;

NOW, THEREFORE, in consideration of the compensation to be paid to the Contractor and of the mutual agreements and covenants herein contained, the parties to this Contract have agreed and hereby agree, as follows:

ARTICLE I. That the Contractor shall (a) furnish all tools, equipment, supplies, superintendent, transportation, and other construction accessories, services, and facilities; (b) furnish all materials, supplies, and equipment specified and required to be incorporated in and form a permanent part of the completed work; (c) provide and perform all necessary labor; and (d) in a good, substantial, and workmanlike manner and in accordance with the requirements, stipulations, provisions, and conditions of the Contract as defined in the attached General Provisions, sometimes referred to as General Conditions in the Contract Documents, said documents forming the Contract and being as fully a part thereof as if repeated verbatim herein, perform, execute, construct, and complete all work included in and covered by the City's official award of this Contract to the said Contractor, such award being based on the acceptance by the City of the Contractor's bid, or part thereof, as follows:

PROJECT NO. 2026-MPO C3 NON-ARTERIAL MILL, PATCH & OVERLAY MAINTENANCE ZONE 6042

ARTICLE II. That the City shall pay to the Contractor for performance of the work embraced in this Contract, and the Contractor will accept as full compensation therefor, the sum (subject to adjustment as provided by the Contract) of _____ AND /100 Dollars (\$_____) for all work covered by and included in the Contract award and designated in the foregoing Article I; payments therefore to be made in cash or its equivalent, in the manner provided in the General Provisions.

ARTICLE III. That the Contractor shall start work within ten (10) days following the date stipulated in a written order from the City to proceed with the work to be performed hereunder, and shall complete the work within the number of consecutive calendar days after the authorized starting date, as stipulated below:

All Work Completed: 120 calendar days

ARTICLE IV. The sworn, notarized statement below shall be signed and notarized before this Contract will become effective.

ARTICLE V. Prior to submitting a final payment request, the Contractor shall furnish a lien waiver certifying that all subcontractors and suppliers have been paid.

ARTICLE VI. If the Contractor has 10 or more full-time employees, and this contract exceeds \$100,000 in total value, Contractor acknowledges and agrees that, in accordance with and pursuant to 21 O.S. 1289.31, Contractor verifies to City that: (i) it does not have a practice, policy, guidance, or directive that discriminates against a firearm entity or firearm trade association, and (ii) will not discriminate against a firearm entity or firearm trade association during the term of this Contract.

IN WITNESS WHEREOF, the parties have hereto set their hands and seals,

this _____ day of _____, 2026.

CITY OF TULSA, OKLAHOMA
a municipal corporation

By: _____

ATTEST: (SEAL)

Mayor

Date: _____

City Clerk

Date: _____

APPROVED:

APPROVED:

City Attorney

Date: _____

Director

Date: _____

CONTRACTOR

By: _____

Printed Name _____

Title

Date: _____

Title

Date: _____

ATTEST:

Corporate Secretary

(SEAL)

AFFIDAVIT

STATE OF _____)
)ss
COUNTY OF _____)

_____, of lawful age, being first duly sworn, on oath says that (s)he is the agent authorized by the Contractor to submit the above Contract to the CITY OF TULSA, Tulsa, Oklahoma.

Signature

Subscribed and sworn to before me this _____ day of _____, 2026.

NOTARY PUBLIC

My Commission Expires:
_____, _____.

City of Tulsa Construction Escalation Process

Step	Contractor Representative(s)	City of Tulsa Representative(s)	Process	Communication / Documentation	Resolution (**)	No Resolution	Typical Time Frame (***)
1.0	Superintendent	Construction Inspector	Field Meeting Request for Information (RFI) may apply	Phone, Text, Email, or RFI / Daily Report	Within Construction Documents	If not resolved within Construction Documents, escalate to 2.0	Same day to 3 days
2.0	Superintendent	Construction Inspector Manager / Construction Inspector	Field Meeting Request for Information (RFI) may apply	Phone, Text, Email, or RFI / Daily Report	Within Construction Documents	If not resolved within Construction Documents, escalate to 3.0	1 day to 3 days
3.0	Project Manager / Superintendent	Construction Manager / Construction Inspector Manager / Construction Inspector Lead Engineer / Project Manager Design Consultant	Contractor submit RFI	Phone, Email, RFI / Daily Report, RFI Log, Progress Mtg	Additional information provided. Potential Allowance Authorization, Extension of Quantities, Change Order, or Other	If not resolved by additional information and within terms of contract, escalate to 4.0	Within 10 calendar days (as ODOT 104.06.B)
4.0	Project Manager / Superintendent	Field Engineering Manager / Construction Manager Lead Engineer / Project Manager Design Consultant	Appeal Construction Manager's Decision	Email, RFI / Daily Report, RFI Log, Progress Mtg	Field Engineering Manager makes determination on appeal. Potential Allowance Authorization, Extension of Quantities, Change Order, or Other	If not resolved by additional information and within terms of contract, escalate to 5.0	Within 10 calendar days (as ODOT 104.06.B)
5.0	Owner / Project Manager / Superintendent	PW Deputy Director and/or other Dept Design Manager / Field Engineering Manager / Construction Manager Lead Engineer / Project Manager Design Consultant	Appeal Field Engineering Manager's Decision	Email, RFI / Daily Report, RFI Log, Progress Mtg	PW Deputy Director and/or other Dept. Design Manager makes determination on appeal. Potential Allowance Authorization, Extension of Quantities, Change Order, or Other	If appeal is not resolved, escalate to 6.0	Within 10 calendar days (as ODOT 104.06.B)
6.0	Owner / Project Manager / Superintendent	Director (*) / PW Deputy Director and/or other Dept Design Manager / Field Engineering Manager / Construction Manager Lead Engineer / Project Manager Design Consultant	Appeal PW Deputy Director's and/or other Dept. Design Manager's Decision	Email, RFI / Daily Report, RFI Log, Progress Mtg	Director makes determination on appeal. Potential Allowance Authorization, Extension of Quantities, Change Order, or Other		Within 10 calendar days (as ODOT 104.06.B)

(*) Director of the Department under whose authority construction is managed by Public Works Field Engineering. Public Works Deputy Director will notify Director of Public Works.

(**) Resolution - Complete information will assist in the most timely resolution. Each escalation step should address any information deficiencies and proposed resolutions, if any, that were unsatisfactory.

(***) Time frames - It is understood that special issues will require a more rapid response and escalation.

PERFORMANCE BOND

KNOW ALL MEN BY THESE PRESENTS: That we, the undersigned, _____, (hereinafter called the Contractor"), duly authorized by law to do business as a construction contractor in the State of Oklahoma, and _____ (hereinafter called the "Surety"), a corporation organized under the laws of the State of _____, and authorized to transact business in the State of Oklahoma, as Surety, are hereby held and firmly bound unto the City of Tulsa, Tulsa, Oklahoma (hereinafter called the "City"), in the penal sum of

_____ Dollars (\$) in lawful money of the United States, for the payment of which, well and truly to be made unto the said City, we bind ourselves, our heirs, executors, administrators, successors, and assigns, jointly and severally, firmly by these presents, as follows:

THE CONDITION OF THE FOREGOING OBLIGATION IS SUCH THAT, WHEREAS, the Contractor has on the _____ day of _____, _____, entered into a written contract with the City of Tulsa, Tulsa, Oklahoma, for furnishing all materials, labor, tools, equipment, and transportation necessary for:

Project No. 2026-MPO C3 NON-ARTERIAL MILL, PATCH & OVERLAY MAINTENANCE ZONE 6042

NOW, THEREFORE, if said Contractor shall well and truly perform and complete said project in accordance with said Contract, Advertisement for Bids, General Conditions, Instructions to Bidders, Bid Form, Plans and Specifications, and related documents, shall comply with all the requirements of the laws of the State of Oklahoma; shall pay as they become due all just claims for work or labor performed and materials furnished in connection with said contract, and shall defend, indemnify and save harmless said City against any and all liens, encumbrances, damages, claims, demands, expenses, costs and charges of every kind, including patent infringement claims except as otherwise provided in said specifications and other contract documents, arising out of or in relation to the performance of said work and the provisions of said Contract, then these presents shall be void; otherwise, they shall remain in full force and effect.

This obligation is made for the use of said City and also for the use and benefit of all persons who may perform work or labor, or furnish any material in the execution of said Contract, and may be sued on thereby in the name of the City.

The Surety, for value received, hereby stipulates and agrees that no change, extension of time, alteration or addition to the terms of the Contract, or to the work to be performed thereunder, or the specifications accompanying same, shall in any way affect its obligation on this bond; and it does hereby waive notice of any such change, extension of time, alteration or addition of the terms of the Contract, or to the work or to the specifications.

IN WITNESS WHEREOF, the said Principal has caused these presents to be executed in its name and its corporate seal to be hereunto affixed by its duly authorized officers, and the said Surety has caused these presents to be executed in its name and its corporate seal to be hereunto affixed by its attorney-in-fact, duly authorized so to do, the day and year first above written.

CONTRACTOR (Principal)

BY: _____ ATTEST: (S E A L)
Date: _____ Date: _____
Title: _____ Title: _____

Attorney In Fact ** Surety (S E A L)
Date: _____ Date: _____

**This date shall match the notarized certificate on the Power-of-Attorney
(Accompany this Bond with Power Of Attorney)

APPROVED AS TO FORM:

City Attorney Date: _____

City Clerk Date: _____

STATUTORY BOND

WHEREAS, the undersigned _____ has entered into a certain contract dated the _____ day of _____, _____, designated as **Project No. 2026-MPO NON-ARTERIAL Mill, Patch & Overlay Maintenance Zone 6042** for the construction of certain public improvements Consisting of _____ to be situated and constructed on and through the property described in said Contract, including all of the work mentioned and described in said Contract, and to be performed by the undersigned strictly and punctually in accordance with the terms, conditions, drawings and specifications thereof, on file in the office of the office of the City Clerk.

NOW, THEREFORE, KNOW ALL MEN BY THESE PRESENTS: That _____, as Principal, and _____

_____, a Corporation organized under the laws of the State of _____, and authorized to transact business in the State of Oklahoma, as Surety, are held and firmly bound unto the State of Oklahoma in the penal _____ sum _____ of

_____ Dollars (\$) _____) in lawful money of the United States, for the payment of which sum well and truly to be made, we bind ourselves, our successors, and assigns, jointly and severally firmly by these presents.

NOW, THEREFORE, if the said Principal shall fail or neglect to pay all indebtedness incurred by Principal or sub-contractors of said principal who perform work in the performance of such contract, for labor and materials and repairs to and parts for equipment used and consumed in the performance of said contract within thirty (30) days after the same becomes due and payable, the person, firm or corporation entitled thereto may sue and recover on this bond the amount so due and unpaid.

The Surety, for value received, hereby stipulates and agrees that no change, extension of time, alteration, or addition to the terms of the contract or to the work to be performed thereunder, or the specifications accompanying the same, shall in any way affect its obligation on this bond, and it does hereby waive notice of any such change, extension of time, alteration, or addition to the terms of the contract or to the specifications.

5/30/06

IN WITNESS WHEREOF, the said Principal has caused these presents to be executed in its name and its corporate seal to be hereunto affixed by its duly authorized officers, and the said Surety has caused these presents to be executed in its name and its corporate seal to be hereunto affixed by its attorney-in-fact, duly authorized so to do, the day and year first above written.

CONTRACTOR (Principal)

BY:

ATTEST: (S E A L)

Date:_____

Date:_____

Title:

Title:

Date:_____

Date:_____

Attorney-In-Fact

**

Surety (S E A L)

**This date shall match the date of the notarized certificate on the Power-of- Attorney.

(Accompany this Bond with Power-Of-Attorney)

APPROVED AS TO FORM:

Date:_____

City Attorney

Date:_____

City Clerk

MAINTENANCE BOND

KNOW ALL MEN BY THESE PRESENTS:

That _____, as Principal,
and _____,

_____ a
corporation organized under the laws of the State of _____ and authorized to transact
business in the State of Oklahoma, as Surety, are held and firmly bound unto the City of
Tulsa in the Penal sum of

_____ Dollars (\$ _____) in lawful money of the United States of America for the
payment of which, well and truly to be made, we bind ourselves and each of us, our
heirs executors, administrators, trustees, successors, and assigns, jointly and severally,
firmly by these presents.

The condition of this obligation is such that:

WHEREAS, said Principal entered into a written contract with the City of Tulsa,
Oklahoma dated _____, _____, for

Project No. 2026-MPO C3 Non-Arterial Mill, Patch & Overlay
Maintenance Zone 6042

all in compliance with the drawings and specifications therefore, made a part of said
Contract and on file in the office of the City Clerk, Tulsa, Oklahoma.

NOW, THEREFORE, if said Principal shall pay or cause to be paid to the City of Tulsa,
Oklahoma, all damage, loss, and expense which may result by reason of defective
materials and/or workmanship in connection with said work, occurring within a period of
one (1) year for all projects, from and after acceptance of said project by the City of
Tulsa, Oklahoma; and if Principal shall pay or cause to be paid all labor and materials,
including the prime contractor and all subcontractors; and if principal shall save and
hold the City of Tulsa, Oklahoma, harmless from all damages, loss, and expense
occasioned by or resulting from any failure whatsoever of said Principal, then this
obligation shall be null and void, otherwise to be and remain in full force and effect.

It is further expressly agreed and understood by the parties hereto that no changes or
alterations in said Contract and no deviations from the plan or mode of procedure herein
fixed shall have the effect of releasing the sureties, or any of them, from the obligation
of this Bond.

06/13/06

IN WITNESS WHEREOF, the said Principal has caused these presents to be executed in its name and its corporate seal to be hereunto affixed by its duly authorized officers, and the said Surety has caused these presents to be executed in its name and its corporate seal to be hereunto affixed by its attorney-in-fact, duly authorized so to do, the day and year first above written.

CONTRACTOR (Principal)

BY: _____ ATTEST: (S E A L)

Date: _____ Title: _____
Date: _____

Date: _____ Attorney-In-Fact ** Surety (S E A L)
Date: _____

** This date shall match the date of the notarized certificate on the Power of Attorney
(Accompany this Bond with Power-Of-Attorney)

APPROVED AS TO FORM:

Date: _____
City Attorney

Date: _____
City Clerk

AFFIDAVIT OF CLAIMANT

STATE OF _____

COUNTY OF _____

The undersigned, of lawful age, being first duly sworn, on oath says that this contract is true and correct. Affiant further states that the work, services or materials will be completed or supplied in accordance with the contract, plans, specifications, orders or requests furnished the affiant. Affiant further states that (s)he has made no payment directly or indirectly of money or any other thing of value to any elected official, officer or employee of the City of Tulsa or any public trust of which the City is a beneficiary to obtain or procure the contract or purchase order.

By: _____

Signature

Name: _____

Company: _____

Title: _____

Subscribed and sworn to before me this ____ day of _____, 20____.

Notary Public

My Commission Expires: _____

Notary Commission Number: _____

GENERAL
CONDITIONS

GENERAL CONDITIONS OF CONTRACT

GC-1. SCOPE:

The Contract stipulations, which follow, are general in scope and may refer to conditions that will not be encountered in the performance of the work included in this Contract, and which are not applicable thereto. Any requirements, provisions, or other stipulations of these General Conditions, which pertain to a nonexistent condition, and are not applicable to the work to be performed hereunder, shall have no meaning in the Contract.

The specifications and drawings are intended to supplement, but not necessarily duplicate each other. Together they constitute one (1) complete set of specifications and drawings, so that any work exhibited in the one and not in the other shall be executed just as if it had been set forth in both, in order that the work shall be completed according to the complete design or designs as decided and determined by the Engineer.

Should anything be omitted from the specifications and drawings which is necessary to a clear understanding of the work, or should it appear various instructions are in conflict, then the Contractor shall request written clarification from the Engineer before proceeding with the construction affected by such omissions or discrepancies.

GC-2. CONTRACT DOCUMENTS :

It is understood and agreed that the Notice to Bidders, Instructions to Bidders, Proposal, Contract, Statutory Bond, Performance Bond, Maintenance Bond, Power of Attorney, Certificates of Insurance, General Conditions, Specifications, Drawings, Addenda, and duly authorized Change Orders, together with any and all supplementary drawings furnished by the Engineer as and when required to make clear and to define in greater detail the intent of the contract, drawings, and specifications, other drawings, specifications, and engineering data furnished by the Contractor (when accepted by the Engineer), and instructions furnished by manufacturers of equipment for the installation thereof, are each and all included in this Contract, and the work shall be done in full compliance and accord therewith.

GC-3. DEFINITIONS:

Any word, phrase, or other expression defined in this paragraph and used in these Contract Documents shall have the meaning herein given:

1. "Contract" or "Contract Documents" shall include all of the documents and drawings mentioned in Paragraph GC-2.
2. "City" shall mean the City of Tulsa, Tulsa County, Oklahoma.
3. "Contractor" shall mean the entity named and designated in the Contract who has entered into this Contract to perform the work covered thereby, and its, his, or their duly authorized agents and other legal representatives.
4. "Engineer" shall mean the Director of Engineering Services, or the Architect or Engineers who have been designated, appointed, or employed by the City for this project, or their duly authorized agents; such agents acting within the scope of the particular duties entrusted to them in each case.
5. "Inspector" shall mean the engineering or technical inspector or inspectors duly authorized by the Engineer, limited in each case to the particular duties entrusted to him or them.
6. "Surety" shall mean any entity that executes, as surety, the Contractor's performance bond, maintenance bond, and statutory bond securing the performance of this Contract.

7. "Drawings" shall mean and include all drawings prepared by the City as a basis for proposals; all drawings submitted by the successful bidder with his proposal and by the Contractor to the City, when and as accepted by the Engineer, and all drawings submitted by the City to the Contractor during the progress of the work as provided herein.

8. "Subcontractor" shall mean a person, firm or corporation to whom any portion of this work has been sublet by the Contractor.

9. "Work" shall mean the task to be performed, necessary for the fulfillment of this Contract.

10. "Unit Price" shall mean the cost per specified unit of measurement of work and/or material.

11. "Lump Sum" shall mean the price of an item of work including all things necessary to complete the item as shown on the drawings and specifications. Such an item is not measured in units but is defined by description.

GC-4. MODIFICATIONS AND ALTERATIONS:

In executing the Contract, the Contractor agrees that the City shall have the right to make such modifications, changes, and alterations as the City may see fit, in the extent, or plan of the Work agreed to be done or any part thereof, or in the materials to be used therein, either before or after the beginning of construction thereof, without affecting the validity of the Contract or the liability of the Sureties upon the performance of this Contract or the Statutory Bond.

Where any modification, change, or alteration increases the quantity of Work to be performed and is within the scope of a fair interpretation thereof, such increase shall be paid for according to the quantity of work actually done, either at Unit Prices included in the Contract, or in the absence of such unit, as extra Work. Modifications and alterations, which reduce the quantity of Work to be done, shall not constitute a claim for damages or for anticipated profits on Work involved in such reduction.

The Engineer shall determine, on an equitable basis, the amount of credit due the City for Work not performed as a result of modifications or alterations authorized hereunder; where the value of the omitted Work is not fixed by Unit Prices in the Contract; allowance to the Contractor for any actual loss incurred in connection with the purchase, delivery, and subsequent disposal of materials and equipment required for use on the Work as actually built; and any other adjustment of the Contract amount where the method to be used in making such adjustment is not clearly defined in the Contract Documents. In this respect, such determination shall be final and binding only when approved by the Director of Public Works.

GC-5. CPM SCHEDULE AND DRAWINGS TO BE FURNISHED BY CONTRACTOR:

The successful contractor shall furnish a CPM schedule per ODOT 108.03B. If at any time, in the opinion of the Engineer, proper progress is not being maintained, such changes shall be made in the schedule of operations, which will satisfy the Engineer that the work will be completed within the period stated in the Proposal. Monthly progress meeting will be conducted to maintain coordination between all project entities.

The Contractor shall furnish all shop, fabrication, assembly, foundation, and other drawings required by the specifications; drawings of equipment and devices, offered by the Contractor for review by the Engineer, shall be in sufficient detail to show adequately the construction and operation thereof; drawings of essential details of any change in design or construction proposed for consideration of the Engineer, by the Contractor in lieu of the design or arrangement required by the Contract or any item of extra work thereunder. The Contractor shall submit to the Engineer, the required number, of each copy of such drawing for the Engineer's review. After review by the Engineer, all such drawings shall become a part of the Contract Documents and the work or

equipment shown thereby shall be in conformity therewith unless otherwise required by the City.

The Engineer's check and acceptance of drawings submitted by the Contractor will be for, and will cover, only general conformity to the plans and specifications and will not constitute a blanket acceptance of all dimensions, quantities, and details of the material or equipment shown; nor shall such acceptance relieve the Contractor of his responsibility for errors contained in such drawings.

GC-6. CONTRACTOR'S BUSINESS ADDRESS:

The business address of the Contractor given in the bid or proposal upon which this Contract is founded is hereby designated as the place to which all notices, letters, and other communications to the Contractor may be mailed or delivered. The delivery at the above named address or depositing in any mailbox regularly maintained by the Post Office, of any notice, letter, or other communication to the Contractor, shall be deemed sufficient service thereof upon the Contractor and the date of said service shall be the date of such delivery or mailing. Such address may be changed at any time by a written instrument, executed by the Contractor and delivered to the Engineer. Nothing contained herein shall be deemed to preclude or render inoperative the service of any notice, letter, or communication upon the Contractor personally.

GC-7. CONTRACTOR'S RISK AND RESPONSIBILITY:

The performance of the Contract and the Work is at the risk of the Contractor until the final acceptance thereof and payment therefor. The Contractor shall take all responsibility of the Work, and shall bear all losses resulting because of the amount or character of the Work, or because the nature of the land in or on which the Work is done is different from what is assumed or expected, or on account of the weather, floods, fire, windstorm, or other actions of the elements, or any cause or causes, whatsoever, for which the City is not responsible. If the Work or any part or parts thereof is destroyed or damaged from any of the aforesaid causes, the Contractor, at his own cost or expense, shall restore the same or remedy the damage.

The Contractor shall, in a good and workmanlike manner, perform all Work and furnish all supplies and materials, machinery, equipment, facilities, and means, except as otherwise expressly specified, necessary or proper to perform and complete all Work required by the Contract within the time herein specified, in accordance with the provisions of these Contract Documents and Drawings of the Work covered by this Contract, and any and all supplemental Drawings. The Contractor shall observe, comply with, and be subject to all terms, conditions, requirements and limitations of the Contract, and shall complete the entire Work to the satisfaction of the Engineer and of the City.

GC-8. ASSIGNMENT AND SUBLETTING OF CONTRACT:

The Contractor shall give his personal attention to the fulfillment of this Contract, and shall not let, assign or transfer it or his right, title, or interest in any part thereof, by attorney or otherwise, or sublet any part of the Work to any other person without the prior consent of the City in writing.

Should any Subcontractor fail to perform his work in a satisfactory manner the Contractor upon notice from the City shall immediately terminate his subcontract. The Contractor shall be fully responsible to the City for the acts and omissions of his Subcontractor, and of persons either directly or indirectly employed by his Subcontractor. Nothing contained in these Contract Documents shall create any contractual relation between any Subcontractor and the City.

GC-9. CONTRACTOR'S REPRESENTATIVES:

The Contractor shall designate a person on the Work site to represent him when absent from the Work site.

GC-10. CONTRACTOR AND HIS EMPLOYEES:

The Contractor shall employ competent foremen, experienced mechanics, and others skilled in the Work in this Contract; and shall promptly discharge any and all incompetent or otherwise unsatisfactory employees. Contractor's employees directly employed to perform the Work shall

not be paid less than the prevailing minimum wage scale.

Necessary sanitary conveniences for the use of employees on the job site, properly secluded from public observation, shall be provided and maintained by the Contractor. The construction and location of the facility and disposal of the contents shall comply with all laws of the City and State, relating to health and sanitation regulations.

GC-11. CONTRACTOR'S RIGHT OF PROTEST:

If the Contractor considers any work demanded of him to be outside the requirements of the Contract, or considers any record or ruling of the Engineers to be unfair, he shall, immediately upon such Work being demanded or such record or ruling being made, ask for written instructions or decisions, whereupon he shall proceed without delay to perform the Work or to conform to the record or ruling; and within ten (10) days after the date of receipt of written instructions or decision, he shall file a written protest with the Engineer, stating clearly and in detail the basis of his objections. Except for such protests and objections made of record in the manner herein specified and within the time stated, the records, rulings, or decisions of the Engineer shall be final and conclusive.

GC-12. INSURANCE AND BONDS:

The CONTRACTOR (and any subcontractors) shall carry and keep in force during this Contract, policies of insurance issued by an insurer authorized to transact business in Oklahoma in minimum amounts as set forth below or as required by the laws of the State of Oklahoma. The Contractor shall also furnish an Owner's Protective Policy in the same amounts naming the City of Tulsa as the assured, issued by the same insurance company as the Contractor's liability coverage and indemnifying the City of Tulsa against any and all actions, claims, judgments or demands arising from injuries of any kind and character sustained by any person or persons because of work performed by the Contractor.

General Liability Insurance with a bodily injury and property damage combined single limit of not less than \$1,000,000.00 for each occurrence.

Employer's Liability and Workmen's Compensation in the amounts as required by law.

The Contractor shall provide proof of such coverage:

- (a) By providing Certificate(s) of Insurance prior to the execution of this contract; and
- (b) By submitting updated Certificate(s) of Insurance with each and every subsequent request for payment. The Certificate(s) should show that the policies are current and should be dated within 30 days of the payment request.

The Contractor shall not cause any required insurance policy to be cancelled or permit it to lapse. If the Contractor cancels, allows to lapse, fails to renew or in any way fails to keep any required insurance policy in effect, the City will suspend all progress and/or final payments for the project until the required insurance is obtained. Further, a Contractor who fails to keep required insurance policies in effect may be deemed by the City to be in breach of contract, ineligible to bid on future projects, and/or ineligible to engage in any new contracts.

The Contractor shall execute and furnish a Statutory Bond for the protection of laborers, mechanics, and material men in a sum equal to one hundred percent (100%) of the contract price.

The Contractor shall execute and furnish a Performance Bond in a sum equal to one

hundred percent (100%) of the contract price.

The Contractor shall execute and furnish a Maintenance Bond in a sum equal to one hundred percent (100%) of the contract price.

Prior to doing blasting, the Contractor shall furnish a Certificate of Insurance, which shall certify that any damage caused by blasting is within the coverage of the Contractor's liability insurance to the full limits thereof.

All bonds and insurance must be executed by a company licensed to do business in the State of Oklahoma and must be acceptable to the City.

GC-13. TIME FOR COMPLETION:

For all projects that will impact the public, a public meeting is required before any work is started. The City of Tulsa requires a minimum of 25 days' notice to get the public meeting scheduled and invitations mailed out.

The Work shall commence within ten (10) days from and after the date of a written work order from the City. The Contractor agrees that the Work shall be performed regularly, diligently, and uninterruptedly at a uniform rate of progress so as to ensure completion within the number of days after the day on which the work order is issued. If the Contractor fails to complete all Work within the time specified, then the Contractor agrees to pay the City, not as a penalty, but as liquidated damages for breach of contract, the Sum of **Two Thousand Five Hundred Dollars (\$2,500.00)** for each and every calendar day beyond the date on which the work was to be completed. The said amount is fixed and agreed upon because of the impracticability and extreme difficulty of fixing and ascertaining the actual damages the City would sustain in such event. It is expressly understood and agreed that the said time for completion of the work described herein is a reasonable time for the completion of same.

The Contractor shall commence work within twenty-four (24) hours of traffic control devices being established at the project location. If the Contractor fails to commence work within twenty-four (24) hours of traffic control devices being established at the project location, then the Contractor agrees to pay the City, not as a penalty, but as liquidated damages the sum of **One Thousand Dollars (\$1,000.00)** per lane for each day of failure to commence work after the specified time set forth. The amount is fixed and agreed upon because of the impracticability and extreme difficulty of fixing and ascertaining the actual damage the City would sustain in such event.

The Contractor will be required to provide a full-time, onsite English-speaking superintendent for this Work for direct contact with City and coordination of Subcontractors. A working foreman is not acceptable as a project superintendent. The superintendent shall be required to be present at the Work site whenever the Contractor or Subcontractors are performing Work. The superintendent shall be a representative of the Contractor with the authority to make decisions. If the Contractor fails to provide a non-working superintendent on a day when Work is being performed, the Contractor agrees to pay the City, not as a penalty, but as liquidated damages for such breach of contract, the sum of **One Thousand Dollars (\$1,000.00)** for each and every calendar day it fails to provide a non-working superintendent at the Work site. This amount is fixed and agreed upon because of the impracticability and extreme difficulty of fixing and ascertaining the actual damages the City would sustain in such an event.

It is further agreed that time is of the essence as to each and every portion of this Contract and the specifications wherein a definite and certain time is fixed for the performance of any act whatsoever; and where under the Contract an allowance of additional time for completion of any Work is made, the new time fixed by such extension shall be of the essence of this Contract.

Failure to complete the Work within the specified time, as set forth in the Contract, may be grounds for disqualification for future consideration for contracts with the City of Tulsa.

Final acceptance of the Work is defined as the completion of the Work and the Contractor moving off the project site. No defined or additional Work is needed.

Contract Evaluation forms will be compiled by City staff upon completion of Work to provide a record of the Contractor's performance for use in subsequent projects.

GC-14. EXTENSIONS OF TIME:

Should the Contractor be delayed in the final completion of the Work by any act or neglect of the City or Engineer, or any employee of either, or strikes, injunctions, fire, or other causes outside of and beyond the control of the Contractor and which, in the opinion of the Engineer, could have been neither anticipated nor avoided, then an extension of time sufficient to compensate for the delay, as determined by the Engineer, shall be granted by the City, provided, however, that the Contractor shall give the City and the Engineer notice in writing of the cause of each delay on the "Extension of Time Request" form enclosed in these documents, and agrees that any such claim shall be fully compensated for by an extension of time to complete performance of the Work.

The Contractor shall submit the "Extension of Time Request" form with each partial payment application. Failure to submit the Extension of Time Request with a partial payment application shall constitute a complete waiver of any claim for time extension for the period covered by the partial payment.

Extensions of time will not be granted for delays caused by unsuitable ground conditions, inadequate construction force, or the failure of the Contractor to place orders for the equipment or materials a sufficient time in advance to ensure delivery when needed. Any extension of time granted by the City shall not release the Contractor and Surety herein from the payment of liquidated damages as provided in the General Conditions of this Contract, for a period of time not included in the original Contract or the time extension, as herein provided.

In no event shall the City be liable or responsible to the Contractor, Surety, or any person for or on account of any stoppage or delay of Work herein provided for by injunction or any other kind of legal, equitable proceedings, or from or by or on account of any delay from any other cause whatsoever.

GC-15. ENGINEER'S POWERS AND DUTIES:

The Engineer will provide general administration of the Contract, including performance of the functions hereinafter described.

The Engineer will be the City's representative during construction and until final payment. The Engineer will have authority to act on behalf of the City to the extent provided herein unless otherwise modified by written instrument, which will be shown to the Contractor. The Engineer will advise and consult with the City, and all of the City's instructions to the Contractor shall be issued through the Engineer. Nothing contained in the Contract documents shall create any contractual relationship between the Engineer and the Contractor.

The Engineer shall at all times have access to the Work as provided elsewhere herein. The Engineer will make periodic visits to the Work site to familiarize himself generally with the progress and quality of the Work and to determine in general whether the Work is proceeding in accordance with the Contract. On the basis of his on-site observations as Engineer, he will keep the City informed of the progress of the Work and will endeavor to guard the City against defects and deficiencies in the Work caused by the Contractor. The Engineer will not be responsible for construction means, methods, techniques, sequences, or procedures, or for safety precautions and programs in connection with the Work and will not be responsible for the Contractor's failure to carry out the Work in accordance with the Contract. Based on such observations and the

Contractor's applications for payment, the Engineer will determine the amounts owing to the Contractor and will issue certificates for payment in amounts as provided elsewhere herein.

The Engineer may provide one or more full-time project representatives to assist the Engineer in carrying out his responsibilities at the Work site. The duties, responsibilities and limitations of authority of the Engineer as the City's representative during construction as set forth herein will not be modified or extended without written consent of the City, the Contractor and the Engineer.

The Engineer will not be responsible for the acts or omissions of the Contractor, any Subcontractors, or any of their agents or employees, or any other persons performing any of the Work.

The Engineer shall decide the meaning and intent of any portion of the specifications, and of any plans or Drawings, where the same are found to be obscure or be in dispute; he shall have the right to correct any errors or omissions therein when such corrections are necessary to further the intent of said specifications, plans or Drawings; the action of such correction shall be effective from the date that the Engineer gives due notice thereof.

Any differences or conflicts, which may arise between the Contractor and other contractors with the City in regard to their work, shall be adjusted as determined by the Engineer.

Neither the Engineer's authority to act under this article or elsewhere in the Contract nor any decision made by the Engineer in good faith either to exercise or not to exercise such authority shall give rise to any duty or responsibility of the Engineer to the Contractor, any Subcontractor, any manufacturer, fabricator, supplier or distributor, or any of their agents or employees or any other person performing any of the Work.

Whenever in the Contract the terms "as ordered", "as directed", "as required", "as allowed", or terms of like effect or import are used, or the adjectives "reasonable", "suitable", "acceptable", "proper", or "satisfactory" or adjectives of like effect or import are used, to describe requirements, direction, review or judgement of the Engineer as to the Work, it is intended that such requirement, direction, review, or judgement will be solely to evaluate the Work for compliance with the Contract (unless there is a specific statement indicating otherwise). The use of any such term or adjective never indicates that the Engineer shall have authority to supervise or direct performance of the Work or authority to undertake responsibility contrary to the provisions of this General Condition.

GC-16. CITY'S RIGHT OF INSPECTION:

The City shall appoint or employ such engineers or inspectors as the City may deem proper to inspect the materials furnished and the work performed, and to determine whether said materials are furnished and work is performed in accordance with the Drawings and specifications therefor. The Contractor shall furnish all reasonable aid and assistance required by the Engineer, or by the Inspectors, for the proper inspection and examination of the Work and all parts thereof, even to the extent of uncovering or taking out portions of finished Work. Should the Work thus exposed or examined prove satisfactory, the uncovering or removing and the replacing of the covering or the making good of the parts removed shall be paid for by the City; however, should the Work exposed or examined prove unsatisfactory, the uncovering, taking out, replacing, and making good shall be at the expense of the Contractor.

Such inspection shall not relieve the Contractor of any obligation to perform said Work strictly in accordance with the Drawings and specifications or any modifications thereto as herein provided; and the Work not so constructed shall be removed and made good by the Contractor at his own expense; and free of all expense to the City, whenever so ordered by the Engineer, without reference to any previous oversight or error in inspection.

GC-17. SUSPENSION OF WORK ON NOTICE:

The Contractor shall delay or suspend the progress of the Work or any part thereof whenever he shall be so required by written order of the City or Engineer, and for such period of time as it or he shall require. Any such order of the City or Engineer shall not modify or invalidate in any way the provisions of this Contract.

GC-18. QUALITY OF WORKMANSHIP:

All workmanship shall be the best possible, both as to material and labor that could be demanded by these Contract Documents or if no specific description is given, it is understood that the best quality is required.

GC-19. SATURDAY, SUNDAY, HOLIDAY, AND NIGHT WORK:

No work shall be done between the hours of 7:00 p.m. and 7:00 a.m., nor on Saturday, Sunday, or legal holidays without the written approval or permission of the Engineer in each case, except such work as may be necessary for the proper care, maintenance, and protection of work already done, or of equipment, or in the case of an emergency.

GC-20. LAWS AND ORDINANCES:

The Contractor shall keep himself fully informed of all existing and current regulations of the City, county, state and national laws which in any way limit or control the actions or operations of those engaged upon the Work, or affecting the materials supplied to or by them. The Contractor shall at all times observe and comply with all applicable ordinances, laws, and regulations; and shall protect and indemnify the City and the City's employees and agents against any claims or liability arising from or based on any violations of the same.

The contractor certifies that it and all of its Subcontractors to be used in the performance of the Contract are in compliance with 25 O.S. Sec. 1313 and participate in the Status Verification System. The Status Verification System is defined in 25 O. S. Sec. 1312 and includes but is not limited to the free Employee Verification Program (E-Verify) available at www.dhs.gov/E-Verify.

The Contractor shall take the necessary actions to ensure its facilities are in compliance with the requirements of the Americans with Disabilities Act (ADA). It is understood that the program of the Contractor is not a program or activity of the City. The Contractor agrees that its program or activity will comply with the requirements of the ADA. Any costs of such compliance will be the responsibility of the Contractor. Under no circumstances will Contractor conduct any activity which it deems to not be in compliance with the ADA.

GC-21. TAXES AND PERMITS:

Unless otherwise specified in these Contract Documents, the Contractor shall pay all sales, use, and other taxes that are lawfully assessed against the City or Contractor in connection with the Work included in this Contract and shall obtain all licenses, permits, and inspections required for the Work. Contractor shall comply with all zoning ordinances of the City, as provided in the Tulsa Zoning Code, Title 42 Tulsa Revised Ordinances and conform with all zoning requirements established by the Tulsa Metropolitan Area Planning Commission and the Board of Adjustment. Contractor can call the Indian Nations Council of Governments (INCOG) at (918) 584-7526, to determine if any zoning requirements must be met.

GC-22. PROTECTION OF PROPERTY:

The protection of City, state, and government monuments, street signs, and other City property is of prime importance, and if the same be damaged, destroyed, or removed, they shall be repaired, replaced, or paid for by the Contractor.

Work occurring within secured facilities will require the Contractor to obtain City of Tulsa issued ID badges for all employees and subcontractors requiring facility gate access. The Contractor will be responsible for all coordination with City Security as necessary to process background checks and issue badges. The City of Tulsa has the right to deny access to any individual based

on evaluation of background check.

GC-23. PATENT RIGHTS:

All fees for any patented invention, article, or arrangement that is based upon, or in any manner connected with the construction, erection, or maintenance of the Work or any part thereof embraced in the Contract and these specifications, shall be included in the price stipulated in the Contract for said Work. The Contractor shall protect and hold harmless the City against any and all demands of such fees or claims.

GC-24. DEFENSE OF SUITS:

In case any action at law or suit in equity is brought against the City or any employer, officer, or agent thereof, for or on account of the failure, omission or neglect of the Contractor to do and perform any of the covenants, acts, matters, or things required by this Contract to be done or performed, or for injury or damage caused by negligence or willful act of the Contractor or his Subcontractors or his or their agents, or in connection with any claim or claims based on the lawful demands of Subcontractors, workmen, material men, or suppliers of machinery and parts thereof, equipment, power tools, and supplies incurred in the fulfillment of this Contract, the Contractor shall indemnify and save harmless the City and its employees, officers, and agents, and the Engineer and any employees, officers and agents thereof, of and from all losses, damages, costs, expenses, judgements, or decrees whatsoever arising out of such action or suit that may be brought without requiring said parties to give any notice thereof.

The City may suspend payments of any sum due or to become due for work done on this Contract until such claims, suits, actions, or proceedings are final and liability has been determined. The amount of such damages or liability shall be deducted from sums due or to become due on this Contract. The City will retain the sums mentioned above until the Contractor furnishes evidence that satisfactory settlement has been made. Any action taken by the City shall not excuse the Contractor for failure to perform this Contract or bar the City from legal action to recover from the Contractor the amount of damages or liability suffered in excess of the amount retained.

The Contractor shall furnish the City with satisfactory evidence upon demand that all persons who have done work on the Contract or furnished materials for the Contract have been paid in full. If such evidence is not furnished, the amount necessary to pay the lawful claims may be retained until such evidence is furnished, or if such evidence is not furnished, the City may apply any sums retained to valid claims and charge the amounts disbursed, including the costs of any action that may be necessary to prove or disprove the claims against the Contractor.

GC-25. REMOVAL OF CONDEMNED MATERIALS AND STRUCTURES:

The Contractor shall remove from the site of the Work, without delay, all rejected and condemned materials or structures of any kind brought to or incorporated in the Work, and upon his failure to do so, or to make satisfactory progress in so doing, within forty-eight (48) hours after the service of a written notice from the Engineer ordering such removal, the condemned material or structures may be removed by the City and the cost of such removal be taken out of the money that may be due or may become due the Contractor by virtue of this Contract. No such rejected or condemned material shall again be offered for use by the Contractor under this or any other Contract under this project.

GC-26. EXTRA WORK:

If a modification increases the amount of the Work, and the added Work or any part thereof is of a type and character which can properly and fairly be classified under one or more Unit Price items of the Bid Form, then the added Work or part thereof shall be paid for according to the amount actually done and at the applicable Unit Price. Otherwise, such work shall be paid for as hereafter provided.

Claims for extra work will not be paid unless the City authorized the work covered by such claims in writing. The Contractor shall not have the right to take action in court to recover for extra work

unless the claim is based upon a written order from the City. Payments for extra Work will be based on agreed lump sums or on agreed Unit Prices whenever the City and the Contractor agree upon such prices before the extra Work is started.

For the purpose of determining whether proposed extra work will be authorized, or for determining the payment method for extra work, the Contractor shall submit to the Engineer, upon request, a detailed cost estimate for proposed extra work. The estimate shall show itemized quantities and charges for all elements of direct cost. The cost shall include only those extra costs for labor and materials expended in direct performance of the extra work and may include:

- (a) **Labor.** For all labor and foremen in direct charge of the specific operations, the Contractor shall receive the rate of wage (or scale) agreed upon in writing before beginning work for each and every hour that said labor and foremen are actually engaged in such work. An amount equal to fifteen (15) percent of the sum of the above items will also be paid the Contractor.
- (b) **Bond, Insurance, and Tax.** For property damage, liability, and workmen's compensation insurance premiums, unemployment insurance contributions and social security taxes on the force account work, the Contractor shall receive the actual cost, to which cost no percentage will be added. The Contractor shall furnish satisfactory evidence of the rate or rates paid for such bond, insurance, and tax.
- (c) **Materials.** For materials accepted by the Engineer and used, the Contractor shall receive the actual cost of such materials delivered on the Work site, including transportation charges paid by him (exclusive of machinery rentals as hereinafter set forth), to which cost ten (10) percent will be added.
- (d) **Equipment.** For any machinery or special equipment (other than small tools), including fuel, lubricants and transportation costs, the use of which has been authorized by the Engineer, the Contractor shall receive the rental rates agreed upon in writing before such work is begun for the actual time that such equipment is in operations on the Work, as provided in the ODOT Subsection 109.04 (b3), to which rental sum no percentage will be added.
- (e) **Miscellaneous.** No additional allowance will be made for general superintendence, the use of small tools, or other costs for which no specific allowance is herein provided.

The form on which field cost records are kept, the construction methods and the type and quantity of equipment used shall be submitted to the Engineer for approval.

Construction equipment which the Contractor has on the Work site and which is of a type and size suitable for use in performing the extra Work shall be used. The hourly rental charges for equipment, including all insurance, taxes, fuel, and operating costs, shall not exceed twelve (12) percent of the latest applicable Associated Equipment Distributors published monthly rental rates and shall apply to only the actual time the equipment is used in performing the extra Work.

When extra Work requires the use of equipment which the Contractor does not have on the Work site, the Contractor shall obtain the approval of the Engineer before renting or otherwise acquiring additional equipment. The rental charges for the additional equipment shall not exceed the latest applicable Associated Equipment Distributors published rental rates.

The Contractor shall file with the Engineer, certified lists in duplicate, of any equipment and the schedule of pay rates for common and semi-skilled labor and operators of various classes which are intended to be used in performing the Work covered by this Contract. These rates shall be subject to the review of the Engineer. This information will be used by the Engineer for computation of extra work as mentioned above; however, if the Contractor fails to file these lists

with the Engineer prior to starting any Work covered by this Contract, then the Engineer's computation shall be based on average wages and rates paid on City work.

GC-27. PAYMENT FOR CONTRACTOR'S PLANT AND MISCELLANEOUS TEMPORARY WORK:

For providing plant, tools, and equipment, and for furnishing, erecting, maintaining, and removing scaffolding and construction plant, construction roads, camps, sanitary conveniences, temporary water supply, trestles, dewatering and other temporary works, the Contractor shall receive no direct payment, but compensation for them shall be considered as having been included in the prices stipulated for the appropriate items.

GC-28. BASIS OF PAYMENT FOR ITEMS OF WORK:

The Contractor shall be paid for all Work performed under the Contract based on the Engineer's computations of as-built quantities and the Contractor's Unit Price or Lump Sum bid per item. This payment shall be full compensation for furnishing all supplies, materials, tools, equipment, transportation, and labor required to do the Work; for all loss or damage, because of the nature of the work, the action of the elements or any unforeseen obstruction or difficulty which may be encountered in the performance of the Work, and for which payment is not specifically provided; for all expense incurred by or because of any suspension or discontinuance of all or any part of the Work; and for faithfully completing the Contract according to the Drawings and specifications and requirements of the Engineer.

GC-29. PAYMENTS:

(1) Partial: If the work is progressing in good and workmanlike manner and if the Contractor is faithfully carrying out the terms of this Contract, approximate estimates of the work done shall be made by the Engineers between the first and fifteenth of each calendar month, including labor actually performed and supplies or materials actually used or incorporated in the Work, and an allowance will be made for acceptable materials satisfactorily delivered, stored and secured on the site of the Work in such amount as can be incorporated in the Work within a reasonable time. The City shall have a lien as owner on any materials stored on the site of the Work.

Each partial estimate for payment shall contain or have attached an affidavit in the form found in this book of specifications, as required by law.

The Contractor shall submit with each partial pay estimate a complete list of vendors and suppliers with itemized purchases and invoices from each vendor. Each list shall contain the name of the contractor or Subcontractor ordering the materials or supplies, and the specific use or placement of each of the materials purchased by the City of Tulsa for this project in accordance with Article IIB of the Contract. At the direction of the Contractor, the City of Tulsa will withhold retainage in the amount of 5% on materials and supplies to be purchased under the terms of this Contract.

Each month that work is performed for which payment is due, the Contractor shall submit to the Engineer an application for such payment, provided said payment is not less than \$1,000.00, and, if required, receipts or other vouchers from Subcontractors showing his payments to them shall be submitted.

Each estimate shall be of the approximate value of all work performed and materials in place or delivered to the Work site, determined as aforesaid from the beginning of this contract to the date fixed for the current estimate, from which shall be deducted five percent (5%) or a lesser amount approved by the City, and, in addition thereto, all previous payments and all other sums withheld under the foregoing provisions of this Contract, the remainder to become due and payable; after the estimate has been reviewed and signed by the Engineer the City shall pay the estimate in the regular manner in the amount determined as due unless it shall be known by the City that there is good reason under the terms of this Contract for withholding same.

When the Contractor has completed Work constituting more than fifty percent (50%) of the total

Contract amount, the retainage will continue at two and one-half percent (2.5%) for the balance of the remaining work; provided, however, that the City or its duly authorized representative has determined that satisfactory progress is being made and upon approval by the Surety.

The Contractor may withdraw any part or the whole of the amount which has been retained from partial payment to the Contractor pursuant to the terms of Contract, upon depositing with or delivery to the City:

- (1) United States Treasury Bonds, United States Treasury Notes, United States Treasury bills, or
- (2) General Obligation Bonds of the State of Oklahoma, or
- (3) Certificates of Deposit from a state or national bank having its principal office in the State of Oklahoma.

No retained amount shall be withdrawn which would represent an amount in excess of the market value of the securities at the time of deposit or of the par value of such securities, whichever is lower.

All partial estimates are subject to correction in the final estimate.

(2) Final Payment:

When this contract, in the opinion of the Engineer, shall be completely performed on the part of the Contractor, the Engineer shall proceed with all reasonable diligence to measure up the Work and shall make out the final estimate for the same, and shall, except for cause herein specified, give to the Contractor, within thirty (30) days after receiving said certificate, an order on the City for the balance found to be due, excepting therefrom such sum or sums as may be lawfully retained under any of the provisions of the Contract; PROVIDED, that nothing herein contained shall be construed to affect the rights of the City hereby reserved to reject the whole or any portion of the aforesaid Work should the said estimate and certificate be found or known to be inconsistent with the terms of this Contract or otherwise improperly given; PROVIDED, that if, in case after the work hereunder has been accepted and final payment made, it shall be discovered that any part of the Contract has not been fully performed or has been done in an improper or faulty manner, the Contractor shall immediately remedy such defect, or, in case of neglect to do so within a reasonable time after notice thereof, shall be liable for and shall pay to the City the cost of remedying such defect or a sum equal to the damages sustained thereby, as the City shall elect, and the acceptance of and final payment for the Work shall be no bar to suit on any bond against any principal or principals, or Surety or Sureties, or both, given for the due performance of the Contract, or for the recovery of such cost or the equivalent of such damage.

The City will pay to the Contractor interest at the rate of three-fourths percent (3/4%) per month on the final payment due the Contractor. For lump sum contracts, the interest shall commence thirty (30) days after the Work under the Contract has been completed and accepted and all required material certifications and other documentation required by the Contract have been furnished the City by the Contractor and shall run until the date when the final payment or estimate is tendered to the Contractor. For contracts bid by Unit Prices, the interest will commence sixty (60) days after the above conditions are satisfied. When contract quantities or the final payment amount is in dispute, the interest-bearing period will be suspended until the conclusion and settlement of the dispute.

GC-30. CONTRACTOR REIMBURSEMENT FOR SURETY BOND:

For contracts of \$1,000,000.00 or more, the Contractor may receive reimbursement for the cost of the surety bonds after issuance of a work order. To receive reimbursement, the Contractor shall submit a standard partial payment form and affidavit, and a copy of the surety bond invoice. The final partial pay estimate will be reduced by the amount paid for surety bond reimbursement.

GC-31. RELEASE OF LIABILITY AND ACCEPTANCE:

The acceptance by the Contractor of the final payment shall operate as, and shall be a release to the City and every employee, officer and agent thereof, from all claims and liability to the Contractor for anything done or furnished for or relating to the Work, or for any act or neglect of the City or of any person relating to or affecting the Work, and, following such acceptance, no person, firm, or corporation other than the signer of this Contract as Contractor, will have any interest hereunder, and no claim shall be made or be valid, and neither the City nor any employees, officers, or agents thereof shall be liable or be held to pay any money, except as herein provided.

It shall be the duty of the Engineer to determine when the Work is completed and the Contract fulfilled, and to recommend its acceptance by the City. The Work herein specified to be performed shall not be considered finally accepted until the City has accepted all the Work.

GC-32. RIGHT OF CITY TO TERMINATE CONTRACT:

If the Work to be done under this Contract shall be abandoned by the Contractor, or if this Contract shall be assigned by him otherwise than as herein provided, or if the Contractor should be adjudged bankrupt, or if a general assignment of his assets be made for the benefit of his creditors, or if a receiver should be appointed for the Contractor or any of his property; or if at any time the Engineer shall certify in writing to the City that the performance of the Work under this Contract is being unnecessarily delayed, or that the Contractor is executing the same in bad faith or otherwise not in accordance with the terms of the Contract; or if the work be not substantially completed within the time named for its completion, or within the time to which such completion date may be extended, then the City may serve written notice upon the Contractor and his Surety of said City's intention to terminate this Contract, and unless within five (5) days after service of such notice upon the Contractor, a satisfactory arrangement is made for the continuance of the Contract, this

Contract shall cease and terminate. In the event of such termination, the City shall immediately serve notice upon the Surety and Contractor, and the Surety shall have the right to take over and complete the Work, provided, however, that if the Surety does not commence performance thereof within fifteen (15) days from the date of said notice of termination, the City may take over the Work and perform same to completion, by Contract or otherwise, for the account and at the expense of the Contractor, and the Contractor and his Surety shall be liable to the City for any and all excess cost sustained by the City by reason of such performance and completion. In such event the City may take possession of and utilize in completing the Work, all such materials, equipment, tools, and plants as may be on the site of the Work and necessary therefor. The Contractor shall not receive any other payment under the Contract until said Work is wholly finished, at which time, if the unpaid balance of the amount to be paid under the Contract shall exceed the expense incurred by the City in finishing the Work as aforesaid, the amount of the excess shall be paid to the Contractor, but if such expense shall exceed the unpaid balance, the Contractor shall pay the difference to the City.

GC-33. ADMINISTRATIVE COSTS AND FEES:

Cash Improvements - In the event the improvements are to be paid for in cash, the costs and fees for publication, engineering, filing, recording, abstracting, acquisition of easements, flushings, and pipe testing, shall be paid by the City unless otherwise provided for in these Contract Documents.

Assessment Improvements: In the event the improvements are to be paid for by the issuance of special assessment bonds, the costs and fees for publication, engineering, filing, recording, abstracting, acquisition of easements, flushing, pipe testing, and other authorized costs shall be added to the contract price and paid for in the same manner as the other Work included in this Contract. The Contractor shall pay the City the amount of said charges before the execution and delivery of the special assessment bonds or other payments. If the Contractor fails, neglects, or refuses to pay said charges within thirty (30) days after the bonds are ready for delivery, he shall pay the City interest at the rate of seven percent (7%) per annum and shall be liable for same in

a civil suit. The Contractor shall pay the pipe testing fees directly to the testing laboratory.

GC-34. PAYMENT OR ACCEPTANCE NOT A WAIVER BY CITY:

Neither acceptance by the City or the Engineer or any employee of either nor any order by City for the payment of money, or the payment thereof, nor any taking of possession by City, nor the granting of any extension of time, shall operate as a waiver of any rights or powers of the City hereunder, and in the event that after the Work hereunder has been accepted and final payment made, it should be discovered that any part of this Contract has not been fully performed, or has been done in a faulty or improper manner, the Contractor shall immediately remedy such defect, or in the event of neglect to do so within a reasonable time after notice thereof, shall be liable for and shall pay to City the cost of remedying such defect, or a sum equal to the damage caused thereby, as City may elect. The acceptance of the Work or final payment therefor shall be no bar to suit against the Contractor or Surety, or both.

GC-35. CONTRACTOR'S OBLIGATION AFTER ACCEPTANCE:

Contractor further agrees, without cost other than is specially provided for in this Contract, at any and all times during one (1) year next following the completion and final acceptance of the Work embraced in this Contract, without notice from City, to repair or rework any work that fails to function properly due to defective material or workmanship and to indemnify, save harmless and defend the City from any and all suits and actions of every description brought against City for, or on account of injuries or damages alleged to have been received or sustained by any party or parties by reasons of, or arising out of the failure of Contractor to repair or rework any work where such failures have occurred, which said injuries or damages are alleged to have been received or incurred within one (1) year from the final acceptance of the Work hereunder, and to pay any and all judgements that might be rendered against City in any suits and actions, together with such expenses or attorney fees expended or incurred by City in the defense thereof, and Contractor hereby expressly waives any notice that might by law be required to be given to them by City of any defect, break, settling, or failure or of any other condition that might be the cause of injury or damage to any person on account of which a claim or suit might be made or filed against City, or a judgement taken for damages against City. It is expressly agreed that the acceptance of the Work by City shall constitute no bar against any person injured or damaged by the failure of the Contractor to perform all of his covenants and agreements hereunder from maintaining an action against the Contractor, or against City from enforcing its rights against the Contractor hereunder.

GC-36. NOTICES:

Any notices or other communications hereunder may be given to Contractor at the address listed in the Proposal, to the Surety at the office of the Attorney-in-Fact signing the bond or at Surety's home office address on file with the Insurance Commissioner of the State of Oklahoma, and to City in care of the Deputy Director of Public Works, or at such other place as may be designated in writing. The delivery to such address, or depositing in any mailbox regularly maintained by the Post Office, of any notice, letter, or other communication to the Contractor, shall be deemed sufficient service thereof, and the date of said service shall be the date of such delivery or mailing.

GC-37. RELATION TO OTHER CONTRACTORS:

Nothing herein contained and nothing marked upon the Drawings shall be interpreted as giving the Contractor exclusive occupancy of the territory or right-of-way provided. The City and its employees, officers, and agents for any just purpose, and other contractors of the City for any purpose required by their respective contracts, may enter upon or cross this territory or occupy portions of it or take materials therefrom as directed or permitted. When two or more contracts are being executed at one time on the same or adjacent land in such manner that the work on one contract may interfere with the work on another, the Engineers shall decide which contractor shall cease work and which shall continue, or whether the work on both contracts shall progress at the same time and in what manner. When the territory of one contract is the necessary or convenient means of access for the transportation or movement of men, machines, or appliances for the execution of another contract, such privilege of access or any other reasonable privilege

may be granted by the Engineers to the contractor desiring it, to the extent, amount, in the manner and at the time permitted. Any decision regarding the method or time of conducting the work or the use of the territory shall not be made the basis of claims for delay or damage except as otherwise stipulated. The Contractor shall not cause any unnecessary hindrance or delay to any other contractors on the premises, and shall bear all damages done to the work of such other contractors by him or by his employees.

GC-38. PARTIAL OCCUPANCY AND USE:

The City, upon advance written notification to the Contractor, shall have the right to occupy and use any completed or partially completed portions of the Work site when such occupancy and use are in the City's best interest, notwithstanding completion of the entire project.

Such partial occupancy and use shall be upon the following terms:

- a. The Engineer shall make an inspection of the portion or portions of the Work concerned, and report to the City his findings as to the acceptability and completeness of the Work. The Engineer's report shall include a list of items to be completed or corrected before final payment.
- b. The City, upon acceptance of the Engineer's report, shall give written notice to the Contractor of the City's intention to occupy and use said portions of the Work site. The City's notice shall include a copy of the Engineer's report, shall clearly identify the portions of the Work site to be occupied and used, and shall establish the date of said occupancy and use.
- c. From the date thus established, the City shall assume all responsibilities for operation, maintenance, and the furnishing of water, gas, and electrical power for the portions of the Work site thus occupied and used. The City shall have the right to exclude the Contractor from those portions of the Work site but shall provide the Contractor reasonable access to complete or correct necessary items of Work.
- d. The one-year guarantee required by the General Conditions shall not begin until completion and final acceptance of the entire project, except as to any items of mechanical or electrical equipment such as pumps, blowers, process equipment, instrumentation, controls, metering equipment, heating, and ventilating equipment and similar items having movable or operable components, and any of which are thus used by the City. For said equipment, the one-year warranty shall start from the date established in the written notice from the City.
- e. Occupancy or use of any space in the Work site shall not constitute acceptance of Work not performed in accordance with the Contract, nor relieve the Contractor of liability to perform any Work required by the Contract but not completed at the time of said occupancy and use.
- f. The Contractor shall not be held responsible for normal wear and tear or damage resulting from said occupancy, except to the extent that such damage is covered by the one-year guarantee.
- g. The partial occupancy and use of any portions of the Work site by the City shall not constitute grounds for claims by the Contractor for release of any amounts retained from payments under the provisions of the Contract. The retained amounts will not be due until completion of the entire project for final acceptance and final payment, as set forth in the General Conditions.

SPECIFICATIONS

(Published in the Tulsa World

June 13, 2021)

Ordinance No. 24616

AN ORDINANCE AMENDING TITLE 11, TULSA REVISED ORDINANCES, ENTITLED "PUBLIC WORKS DEPARTMENT" BY AMENDING CHAPTER 10, ENTITLED "STANDARD SPECIFICATIONS FOR HIGHWAY CONSTRUCTION" BY AMENDING SECTION 1000 AND SECTION 1001; PROVIDING FOR SEVERABILITY; REPEALING ALL ORDINANCES OR PARTS OF ORDINANCES IN CONFLICT HEREWITH AND ESTABLISHING AN EFFECTIVE DATE.

BE IT ORDAINED BY THE CITY OF TULSA:

Section 1. Amendment of Title 11, Chapter 10. That Title 11, Chapter 10, Tulsa Revised Ordinances, entitled "Standard Specifications for Highway Construction" be and the same is hereby amended and shall recite in its entirety as follows:

"CHAPTER 10. STANDARD SPECIFICATIONS FOR HIGHWAY CONSTRUCTION

Section 1000. Adoption of State Standard Specifications.

Section 1001. Additions, Revisions, Deletions and Exceptions.

SECTION 1000. ADOPTION OF STATE STANDARD SPECIFICATIONS.

That certain document, a bound copy and electronic copy of which has been filed in the Office of the City Clerk of the City of Tulsa, being marked and designated as Standard Specifications for Highway Construction, 2019 Edition, as published by the Oklahoma Department of Transportation, is hereby adopted as the standard specifications for public improvement projects for the City of Tulsa with the additions, revisions, deletions and exceptions as set forth in SECTION 1001 of this chapter.

SECTION 1001. ADDITIONS, REVISIONS, DELETIONS AND EXCEPTIONS.

1001.A. The following definitions, listed as numbered in the 2019 Edition of the Standard Specifications for Highway Construction, are hereby revised and amended for all sections of this chapter as follows:

101.03. Abbreviations and Acronyms. In Table 101:1, add the following abbreviations and expressions:

- ADA - American with Disabilities Act, excluding Chapter 500
- ADA – Adjusted Daily Average, when used in Chapter 500
- ADAAG - American with Disability Act Accessibility Guidelines
- COT - City of Tulsa

- PROWAG – Public Rights-of-Way Accessibility Guidelines

101.05. Definitions. Add the following subsections:

- **“101.05.CY. City of Tulsa (COT).** The City of Tulsa, Oklahoma, a municipal corporation acting by and through its duly authorized officers and agents.”
- **“101.05.CZ. Non-Collusive Bidding Certificate.** Replace all references to ‘Non-Collusive Bidding Certificate’ with ‘Non-Collusion Affidavit’.”
- **“101.05.DA. Qualified Products List (QPL).** All references to ‘ODOT Traffic Engineering Division Qualified Products List (QPL)’ or ‘QPL’ shall mean ‘the City of Tulsa, Traffic Engineering Division Approved Products List’.”
- **“101.05.DB. State Construction Engineer.** The City Engineer of the City of Tulsa or authorized designee.”

101.05.A. Acceptance Date. Delete section.

101.05.V. Commission. Replace definition with “The City of Tulsa, Oklahoma, a municipal corporation acting by and through its duly authorized officers and agents.”

101.05.Y. Contract. Replace definition with “The written agreement between the City of Tulsa and the Contractor setting forth obligations of the parties thereunder, including, but not limited to, the performance of the work, the furnishing of labor and materials, and the basis of payment.

The Contract includes the Notice to Bidders, Proposal, Contract Form, all Contract Bonds, Specifications, Special Specifications, Special Provisions, all Plans, Work Orders and Change Orders that are required to complete the construction of the work in an acceptable manner, including authorized extensions.”

101.05.AG. Department. Replace definition with “The City of Tulsa, Oklahoma, a municipal corporation acting by and through its duly authorized officers and agents.”

101.05.AI. Director. Replace definition with “The Director of the Engineering Services Department or the Director of any successor department which has the responsibility for general engineering services for the City of Tulsa.”

101.05.AL. Engineer. Replace definition with “The City Engineer of the City of Tulsa or authorized designee.”

101.05.AO. FAST Guide. Replace definition and all references to “FAST Guide” with “City of Tulsa Acceptance Sampling/Testing Standard Specifications.”

101.05. AT. Holiday. Replace definition with “Days declared to be holidays for regular Civil Service employees of the City of Tulsa.”

101.05.AV. Inspector. Replace definition with “The City of Tulsa’s authorized representative assigned to inspect the work.”

101.05.BF. Materials Division. Replace definition with “The Director of the Engineering Services Department or the Director of any successor department which has the responsibility for general engineering services for the City of Tulsa.”

101.05.BG. Materials Engineer. Replace definition with “The City Engineer of the City of Tulsa or authorized designee.”

101.05.CC. Right-of-Way. Replace definition with “Right-of-Way or ROW shall mean the surface, the airspace above ground, and the area below the surface of any public street, highway, parkway, lane, path, alley, sidewalk, boulevard, drive, bridge, tunnel, stormwater drainage system, easement, park, or similar property in which the City of Tulsa now or hereafter holds a property interest and/or a maintenance responsibility which, consistent with the purposes for which it was granted or dedicated, may be used to install, operate and maintain facilities.”

101.05.CD.(16). Sidewalk/Bicycle Path. Add the following sentence to the existing definition: “Refer to the Revised Ordinances of the City of Tulsa, Title 37 – Tulsa Traffic Code, Chapter 1 and Chapter 10 for definition of bicycle.”

101.05.CH. State. Replace definition with “The City of Tulsa, Oklahoma, a municipal corporation acting by and through its duly authorized officers and agents.”

101.05.CS. Traffic Engineering Division. Replace definition with “The City of Tulsa Traffic Engineering Division or any successor division which has the responsibility for traffic engineering services for the City of Tulsa.”

1001.B. City of Tulsa exceptions and amendments to the following provisions, listed as numbered in the 2019 Edition of the Standard Specifications for Highway Construction, are hereby revised, amended and described as follows:

102.01. Pre-Qualification. Delete text of section, and replace with “The City of Tulsa requires General / Prime Contractors to be Prequalified according to Title 11, Chapter 11 of the Revised Ordinances of the City of Tulsa.”

102.04. Refusal of Proposals. At the end of the bulleted list, add the following bulleted list item: “The bidder has failed to comply with Small Business Enterprise requirements of a previous City of Tulsa contract.”

102.06. Examination of Plans, Specifications, Special Provisions, and the Work Site. Replace the fourth paragraph with “The City of Tulsa may have boring logs and subsurface reports used in determining design criteria. Bidders may request to inspect these documents, relevant to the currently advertised project, by contacting the Contract Administrator at the following address during normal business hours:

City of Tulsa
Engineering Services Department

2317 S Jackson Ave
Tulsa, OK 74107

102.08. Nonresponsive Proposals. At the end of the bulleted list, add the following bulleted statement: "The bidder does not properly comply with Small Business Enterprise requirements in accordance with the Proposal Forms."

102.10. Delivery of Proposal. Delete text of section, and replace with the following:

"Each bid Proposal shall be completed electronically on the electronic media provided, then printed, signed and submitted along with the electronic media and the complete bound copy of the contract documents or as instructed in the Notice to Bidders. In the event of a discrepancy between the pricing on the electronic media and the hard copy of a Proposal, the hard copy pricing will govern. If an electronic media is not provided, and the bid Proposal is manual, the bid Proposal shall be submitted in ink. The written words shall govern over the figures. Erroneous entries shall be lined out, initialed by the bidder, and the correct entry inserted. The unit price bid must cover all expense for furnishing the labor, materials, tools, equipment, and apparatus of every description to construct, erect, and furnish all work required by and in conformance with the Plans and Specifications.

Each bid shall be enclosed in a sealed envelope addressed to

City Clerk's Office
The City of Tulsa
One Technology Center
175 E. 2nd Street, Suite 260
Tulsa, Oklahoma 74103

or as otherwise instructed in the Notice to Bidders, and identified on the outside with the words:

'PROJECT NO. _____,

Pre-qualification Certificate Number _____.'

All addenda to the contract documents shall accompany the bid when submitted.

Any bid received more than ninety-six (96) hours excluding Saturdays, Sundays and holidays before the time set for the opening of bids, or any bid received after the time set for opening of bids, shall be considered "non-responsive" and shall be returned unopened to the bidder."

102.13. Public Opening of Proposals. Delete text of section, and replace with "Proposals shall be publicly opened and read on the date and at the hour and place set forth in the advertisement and Notice to Bidders in the manner established by the City of Tulsa."

102.16. Non-Collusive Bidding Certification.

- Replace the Non-Collusion Bidding Certification form with the following City of Tulsa Non-Collusion Affidavit form:

103.08. Approval of Contract. Delete text of section, and replace with “The Contract shall not be binding upon the City of Tulsa until it has been executed and approved in the manner set forth in the Tulsa City Charter.”

104.01. Purpose of Contract. After the first two (2) sentences, delete the rest of the section.

104.07. Maintenance of Traffic. Revise the first sentence to recite “Keep all roads, sidewalks, and bicycle paths open to all traffic as shown on the plans.”

105.17. Project Completion and Acceptance. At the beginning of the section add, “This section does not apply to Infrastructure Development Projects (IPDs). For IDPs, refer to Title 35 of the Revised Ordinances of the City of Tulsa.”

105.17.B. Project Completion. In the first sentence of the last paragraph, replace “The Resident Engineer will” with “The Resident Engineer may”.

105.17.C. Final Acceptance. Delete text of section, and replace with “Final Acceptance is the date on which the Request for Action (RFA) for final payment has been signed by the Mayor of the City of Tulsa.”

106.01.A. Material Acceptance. At the end of this section, add the following paragraph: “For conflicts among ODOT Standard Specifications, ODOT Standard Materials Test Methods, and City of Tulsa Acceptance Sampling/Testing Standard Specifications, the City of Tulsa Acceptance Sampling/Testing Standard Specifications shall take precedence.”

106.01.B. Buy America. Delete Section.

106.04.D. Distribution of Certifications. Delete text of section, and replace with “The Contractor shall submit certifications to the Engineer with another copy mailed to:

Field Engineering
City of Tulsa
Engineering Services Department
2317 S Jackson Ave
Tulsa, OK 74107”

106.05. Plant Inspection. In this section, replace all references to “Oklahoma City” with “Tulsa.”

106.11. Guarantees and Warranties. In the first paragraph replace “six months” with “twelve months” and “six-month” with “twelve-month”.

107.01. Laws, Rules, and Regulations to be Observed. At the end of this section add the following:

“The contractor shall certify that it and all of its Subcontractors to be used in the performance of the Contract are in compliance with 25 O.S. Sec. 1313 and participate in the Status Verification System. The Status Verification System is defined in 25 O.S. Sec. 1312 and

includes but is not limited to the free Employee Verification Program (E-Verify) available at www.dhs.gov/E-Verify.

The Contractor shall take the necessary actions to ensure its facilities are in compliance with the requirements of the Americans With Disabilities Act (ADA). It is understood that the Contractor's internal ADA program is not a program or activity of the City of Tulsa. The Contractor agrees that its program or activity will comply with the requirements of the ADA. Any costs of such compliance will be the responsibility of the Contractor. Under no circumstances will Contractor conduct any activity which is not in compliance with the ADA."

107.06. Barriers, Barricades, and Warning Signs. Before the first paragraph, add "In this section, the term "traffic" includes vehicular, pedestrian and bicycle traffic."

107.14. No Waiver of Legal Rights. Delete section.

107.19. Regulated Floodways. At the end of the section, add "The Contractor shall also follow the requirements of Title 11A of the Revised Ordinances of the City of Tulsa."

107.20. Stormwater Management. After the first sentence, add "The Contractor shall also follow the requirements of Title 11A of the Revised Ordinances of the City of Tulsa."

108.01. Subletting of Contract. Delete the last sentence of the first paragraph.

108.02. Notice to Proceed and Preconstruction Conference. Delete the first sentence in the second paragraph, and replace with "After the Contractor and Resident Engineer hold a preconstruction conference, the Contractor shall receive a Notice to Proceed before the start of construction."

108.07.B.(1) Extensions for Adverse Weather. After the first sentence in the second paragraph, add "Extensions of Contract Time will not be granted if conditions exist such that the Contractor could work at least 4 hours."

108.07.B.(3). Winter Time Suspension. Delete section.

108.08. Incentive/Disincentive for Early/Late Completion. Delete section.

108.09. Failure to Complete on Time.

- In the first sentence, delete "in accordance with Table 108:1, "Schedule of Liquidated Damages.""
- Delete Table 108:1.

109.04.B.(3). Equipment.

- In first paragraph, delete the last two sentences, and replace with the following:

"The Department will determine the maximum allowable rate as listed in the most current edition of the *Heavy Construction Costs with RSMMeans data*, published by The Gordian

Group. The Department will calculate the hourly rental rate in accordance with the following equation:

$$H = [(M \times R) / 176] + O$$

Where

H = Hourly rental rate,
M = Monthly rental rate,
R = City cost index / 100, and
O = Hourly operating cost.

- In the second paragraph, delete the last two sentences.

109.04.B.(4)(f). Employee Fringe Benefits. Delete text of section, and replace with “The City of Tulsa will not pay for the additional costs of employee fringe benefits incurred by the Contractor for labor during the period the disputed work was in progress.”

109.06. Progress Payments. Revise the first sentence of the second paragraph to recite “The Resident Engineer will make monthly progressive estimates.”

109.08. Final Payment. Delete last paragraph, and replace with “If the Contractor does not sign and return the Final Estimate within 90 days of receipt, the Engineer may start action to administratively close the project.”

109.10.A. Recoverable Costs. Delete section.

201.04.A. Clearing. Delete the fourth sentence of the first paragraph, and replace with “Remove branches that overhang the roadway to at least 20 ft [6 m] above the road surface and at least 35 ft [11 m] above the road surface at traffic signals.”

201.06. Basis of Payment. In this section, delete all references to “Lump Sum”, and replace with “Square Yard [Square Meter]”.

202.04. Construction Methods. In the second paragraph delete, “If the contract requires ground disturbance greater than one acre total.”

202.04.D.(2). Mandatory Sources Designated on the Plans. Delete sentence, and replace with “If the Plans show the source of selective subgrade topping, excavate the material at the specified source, haul to the specified location, and place.”

202.05.A. Unclassified Excavation. Delete the second sentence of the first paragraph.

209.04. Construction Methods. At the end of the second paragraph, add the following: “Clean inlet and outlet channels within the right-of-way.”

220.04.C. Contractor Responsibilities for SWPPP. In the first sentence of the second paragraph, replace “recommended” with “required”.

220.04.H.(3). Earthwork Operations. Delete first paragraph, and replace with “Protect excavation or embankment slopes as construction progresses with placement of temporary (e.g. seeding, mulching, soil retention blankets, or other approved soil stability), or permanent (e.g. seeding, sprigging, or sodding) erosion control measures. Obtain approval from the Resident Engineer in the preconstruction schedule for any increase or decrease in the amount of the area exposed by construction operations. No exposed area shall remain unprotected without being stabilized. Install temporary or permanent erosion or sediment control measures on excavation or embankment slopes as work progresses in vertical increments of not more than 10 ft [3 m] unless otherwise directed by the Resident Engineer.”

220.05. Method of Measurement. In the bulleted list, delete the sixth bulleted item.

221.01. Description. In the last sentence, replace “OOPDES” with “OPDES”.

221.02. D. Temporary Sediment Filter. Revise the first sentence to recite “Provide fiber log for Type I-A and I-B sediment filter in accordance with Subsection 221.02.H, ‘Temporary Fiber Log.’ Provide material for Type I-C sediment filter in accordance with Subsection 221.02.C, ‘Temporary Silt Fence.’”

228.02. Materials. For the first item listed in the table, delete “Nylon”.

230.01. Description. Delete “Bermuda”.

230.02. Materials. Delete all references to “Bermuda” from this section.

231.04.C.(1). Planting Seasons and Weather Restrictions. In the first sentence of the second paragraph, replace “suspend” with “Suspend”.

317.04.A. Mix Design and Proportioning. In the bulleted list, insert “•” before “Compressive strength at 7 days”.

317.04.F. Acceptance.

- Delete the first paragraph.
- At the end of the second paragraph add “Failure to reach strength between 600 psi [4,150 kPa] and 2,000 psi [13,800 kPa] will result in rejection of the work.”

317.06. Basis of Payment. Delete the third and fourth paragraphs and Table 317:1. Replace with the following: “ODOT Acceptance and Strength Pay Factors shall not be used. Failure to meet criteria in Subsection 317.04.F will result in rejection of the work.”

401.04.A.(1). Surface Elevation and Smoothness. Delete paragraph, and replace with “Refer to the City of Tulsa Standard Specifications for Pavement and Bridge Deck Smoothness.”

403.04.A.(2). Seasonal Limitations. Delete paragraph and Table 403:1, and replace with “The Department will evaluate claims for extension of Contract Time in accordance with Subsection 108.07, when temperature and weather limitations in Table 403:2 are not met.”

405.04.G. Spreading and Finishing. In the last paragraph, replace “ODOT Bridge Division” with “Department”.

406.04.F. Weather and Seasonal Limitations. Delete the second paragraph.

410.04.E. Aggregate Application Rate. Delete the third and fourth sentences, and replace with “The Contractor shall overlay the deficient area at no additional cost to the Department.”

410.05. Method of Measurement. Delete text of section, and replace with “The Resident Engineer will measure completed Micro Surfacing by the square yard [square meter].”

410.06. Basis of Payment. Delete all Pay Items and Pay Units in the table and replace with the following Pay Item and Pay Unit: “MICRO SURFACING, Square Yard [Square Meter]”.

411.03.C. Pavers. After the first paragraph add the following paragraph and Table 411.03.C:1. “Pavers shall be capable of placing a minimum paving width in one (1) lift as shown in Table 411.03.C:1. Longitudinal joints in the surface layer shall correspond with the locations indicated in Table 411.03.C:1.”

Table 411.03.C:1 Minimum Paving Widths		
Roadway Classification	Minimum Paving Width	Location of Longitudinal Joints
Arterials	one (1) full lane width	At edges of traffic lanes
Non-Arterials	one-half (½) road width	At centerline of road
Trails and bike lanes	full width of trail/bike lane	At edges of trail/bike lane

411.03.F. Material Transfer Vehicle.

- In the fourth paragraph, replace “Bridge Division” with “Department”.
- In the seventh paragraph, replace “500 ton [450 metric ton]” with “100 ton [90 metric ton]”.

411.04. Construction Methods. At the beginning of this section, add the following:

“Prior to paving operations, submit a paving plan indicating the sequence of paving passes, pass widths, pass thicknesses, and requested temporary street closures.

The contractor shall not drive empty or loaded trucks or equipment across newly paved areas for the construction period.”

411.04.D. Control Strip Requirements.

- Delete the first paragraph.
- In the second paragraph, replace “500 ton [450 metric ton]” with “100 ton [90 metric ton]”.
- Delete the last paragraph, and replace with “If the initial asphalt control strip produces failing results, make adjustments to production and placement procedures, and repeat the

test process for a second control strip. If required, create additional asphalt control strips on the shoulder until an acceptable mixture is produced.”

411.04.I. Spreading and Finishing.

- After the second sentence in the fourth paragraph, add “Once paving begins the Contractor should have sufficient trucks available to deliver asphalt materials in a continuous operation.”
- After the fourth paragraph, add the following paragraph: “A leveling or “wedge” course may be required to establish the required cross-slope for the finished overlay. Adequate transitions to side streets and driveways must be provided. Paving shall extend to the returns of all side streets. Special consideration should be given to prevent ponding at side street intersections.”

411.04.J.(1). General.

- Delete the second paragraph, and replace with the following:

“Ensure longitudinal joints in the surface layer correspond with locations indicated in Table 411.03.C:1.

Transverse joints shall be kept to a minimum. At a minimum, each lane shall be continuously laid without cold joints either from intersection to intersection or a length of 500 ft.”
- Delete the last sentence in the last paragraph.

411.04.K.(2). Acceptance. Delete the second sentence in the third paragraph.

411.04.K.(2).(a). Layers At Least 1½ in [38 mm] Thick.

- In the second paragraph, delete the first sentence, and replace with “Asphalt density tests for each lot will be performed at random sample locations.”
- Delete Table 411:2 and the last paragraph in the section, and replace with the following:

“ODOT Pay Adjustments for Lot Density shall not be used. Failure of any sample within the lot to reach density within 92.0 to 97.0 percent of the Maximum Theoretical Density will result in rejection of the entire lot. The Contractor shall remove and replace unacceptable lots at no additional cost to the Department.”

411.04.K.(2).(b). Layers Less Than 1½ in [40mm] Thick. In the second paragraph, replace “500 yd² [500 m²]” with “400 yd² [330 m²]”.

411.04.N.(2).(a). Basis of Acceptance and Payment.

- In the first paragraph,
 - In the first sentence, delete “and payment”;
 - After the first sentence, add the following: “The Resident Engineer may also consider other characteristics, including but not limited to, pavement smoothness.”

- In the second paragraph, delete the second through the last sentence.
- Delete the fifth through the last paragraph, and replace with “ODOT pay factors for density, asphalt cement content, and air voids shall not be used. Failure to reach density of 92.0 to 97.0 percent of the Maximum Theoretical Density, asphalt cement content of +/- 0.40 of job mix formula, air voids greater than 1.5 deviation from target, or specified thickness of asphalt will result in rejection of the entire lot. The Contractor shall remove and replace unacceptable lots at no additional cost to the Department.

411.04.N.(2).(b). Resident Engineer’s Acceptance Procedures. Delete the second paragraph, the bulleted list, and Table 411:4; replace with “The Resident Engineer may perform varying amounts of sampling and testing per lot in accordance with the City of Tulsa Acceptance Sampling/Testing Standard Specifications.”

411.06.B.(2). Asphalt Binder Price Adjustment (ABPA). Delete the last paragraph, and replace with “ODOT will establish the Monthly Asphalt Binder Price Index each month and post the information to the ODOT website at <http://www.okladot.state.ok.us/contractadmin/pdfs/binder-index.pdf>.”

414.02. Materials.

- Delete “Fly Ash” from Table.
- At the end of the section, add the following:
 “Fly Ash is not allowed in any concrete mixture unless otherwise specified in the Plans or Special Provisions.”

414.03.B. Placing and Finishing Equipment. After the first sentence, add the following: “If paving is not performed by a slip form paver, a hand vibrator shall be required.”

414.04.R. Acceptance of Pavement. Delete text of section, and replace with the following: “ODOT pay factors shall not be used. Failure to reach the gradation specified, air content of 4.5% to 7.5%, or target strength of the mix design will result in rejection of the entire lot. Failure to provide pavement thickness equal to or greater than what is specified will result in rejection of the entire lot.”

414.04.R.(a). Engineer’s Acceptance Procedures. Delete text of section and Table 414:2. Replace with “Refer to City of Tulsa Acceptance Sampling/Testing Standard Specifications.”

414.06. Basis of Payment. Delete the last sentence in this section.

509.06. Basis of Payment.

- Delete the second through the fifth paragraph and Table 509:7. Replace with the following: “ODOT pay factors for strength and air content shall not be used. Failure to reach the specified strength or the target air content within a deviation of 1.5% will result in rejection of the work. Check any outlying concrete cylinder breaks and air entrainment tests in accordance with ASTM E 178 Table 1, Upper 10% Significance Level.”

- In the sixth paragraph, revise the first sentence to recite “If the concrete is rejected by the Engineer, the Contractor may elect to core the represented concrete at no additional cost to the Department.”

515.04.C. Sampling and Testing of Bridge Decks and Approaches. Delete the first paragraph and bulleted list. Replace with “Refer to City of Tulsa Acceptance Sampling/Testing Standard Specifications for lot size.”

515.04.D.(2). Bridge Decks and Approach Slab Surfaces.

- In the first paragraph, delete the third sentence.
- Delete sections (a), (b) and (c).
- Add the following:

“The percentage of absorption (using test results from OHD L39 shall be less than or equal to 1.0. The depth of penetration (using test results from OHD L 40) shall be greater than or equal to 0.15 inches. If absorption and penetration requirements are not met, reapply penetrating water repellent at no additional cost to the Department until requirements are met.”

516.02.C. Casings.

- In the first sentence of the third paragraph, add the word “licensed” after “Registered Professional Engineer”.
- In the fourth paragraph, delete the second sentence, and replace with “Use permanent interior casings in accordance with ASTM A760 and AASHTO M36.”

516.04.C.(7). Concrete Acceptance. Delete the second and third sentence. Replace with the following: “ODOT pay factors for concrete strength shall not be used. Failure to reach the specified strength will result in rejection of the work.”

610.04.F. Tactile Warning Device. Delete text of section, and replace with the following:

“Install tactile warning devices in accordance with the manufacturer’s specifications and the City of Tulsa Standard Drawings. Tactile Warning Devices shall consist of Cast-In-Place Tactile Panels in accordance with 733.1, “Tactile Warning Device Material”.

Tactile panels shall be cast into the wet concrete. Surface applied products shall not be allowed. The panels shall extend the full width of the ramp or landing area and shall extend a minimum of two (2) feet in the direction of pedestrian travel. Panels shall be placed perpendicular to the direction of travel unless specifically noted otherwise or approved by the Engineer prior to installation.

All construction shall meet current ADAAG and PROWAG Guidelines.”

611.01. Description. In the first sentence, delete “, brick masonry,”.

611.02.A. General.

- Delete “Clay Brick” and “Concrete Brick” from the table of materials.

- In the second paragraph, delete “brick masonry or”.

611.04.B. Clay Brick or Concrete Brick. Delete section.

615. Sanitary Sewer Pipe Conduits. Delete section.

616. Water Pipe and Fittings. Delete section.

623. Guardrail and End Treatments. Revise the section title to recite “Guardrail, End Treatments, and Impact Attenuators”.

623.01. Description.

- In bulleted list, add the item, “Guardrail Impact Attenuators”.
- In the last sentence of the last paragraph, after “Ensure the GETs”, add “and Guardrail Impact Attenuators”.

623.04. Construction Methods. Add the following subsection:

“623.04 H. Guardrail Impact Attenuators

Ensure experienced workers fabricate and install guardrail impact attenuators as shown on the Plans.

Construct guardrail impact attenuators with certified, crash tested hardware. Ensure NCHRP 350 TL-3 certification for substituted hardware and that the product appears on the Traffic Engineering Division’s Qualified Product List (QPL). Obtain the Resident Engineer’s approval of substitutions before installation.”

623.06. Basis of Payment. Add Pay Item “(J) Guardrail Impact Attenuator” with a Pay Unit of “Each”.

624.01. Description. In the bulleted list, add the bulleted item, “Fence, Other (Like Kind)”.

624.02. Materials. In the table, add the Material, “Fence, Other (Like Kind)” with Section or Subsection of “732.10”.

624.06. Basis of Payment. Add Pay Item, “(H) Fence, Other (Like Kind)” with a Pay Unit of “Linear Foot [Meter]”.

642.06. Basis of Payment. In the table, for both Pay Items, delete the Pay Unit of “Lump Sum”, and replace with “Each”.

701.01.B. Cement Substitution. Delete text of section, Table 701:2, and Table 701:3. Replace with “Cement substitutions shall not be used in concrete mixtures.”

701.19.A. General. Controlled Low-Strength Material (CLSM). In the first sentence, delete “fly ash,”.

701.19.B. Mix Design. In the table, delete the Material, “Fly Ash”.

702.01.A. General. In the second paragraph

- Delete the first sentence, and
- In the last sentence, delete “PCC from one source (power plant) and”.

702.01.B. Requirements for Portland Cement Concrete Use. Delete section.

702.02. Slag Cement. Delete section.

702.03. Cement Kiln Dust. Delete section.

702.04. Silica Fume. Delete section.

708.04. Composition of Mixtures. In Table 708:6, under “Other Mixture Requirements”, add a row as follows:

	S2	S3	S4	S5 / RIL	S6
Asphalt Cement (for Non-Arterial pavements only) % of mix mass		≥ 5.0	≥ 6.0	≥ 6.0 / NA	

711.06.D.(1). Acrylic Emulsion Polymer. In the second sentence, after “44 percent by”, delete “weight [mass]”, and replace with “total weight of the acrylic emulsion polymer.”

719.04.A. Description. In the second sentence, after “Type III” add “, Type IV, or Type IX”.

719.05.C. Material and Application. In the first sentence, delete “baking screen enamel or”.

719.05.E. Tests. In the first sentence revise “Ensure screening enamel, stencil pastes, and process inks” to recite “Ensure stencil pastes and process inks”.

726.02. Flexible Conduits. In Table 726:3, under Nonmetallic conduits—culverts, for Corrugated Polypropylene Pipe, delete the requirement for “AASHTO M330”, and replace with “COT 215”.

732. Materials for Guardrail, Guide Posts, Bridge Rail, Miscellaneous Railing, and Fences. Add the following subsection:

“732.10 Fence, Other (Like Kind)

Provide fence, other (like kind), in accordance with contract documents.”

733. Miscellaneous Materials. Add the following subsection:

“733.1 Tactile Warning Device Material

Provide cast-in-place tactile panels to be embedded into wet concrete. Surface applied products are not allowed. The panels shall meet the size and spacing requirements shown in the plans or the City of Tulsa Standard Drawings.

The tactile panels shall be composed of cast iron or vitrified polymer composite material. The color of the tactile panels shall comply with ADAAG and PROWAG color contrast requirements. Vitrified polymer composite panels shall be yellow and conform to Federal Color No. 33538. The color shall be homogeneous throughout the product. Any variations in color shall be approved by the Engineer prior to installation.

Tactile panels shall meet current ADAAG and PROWAG Guidelines.”

735.01. Sodding and Sprigging Materials. Within subsections A, B and C, delete the word “Bermuda”.

735.01.B.(1). Solid Slab Sod. At the end of the first paragraph add “Nylon mesh shall not be allowed in solid slab sod.”

740.01. Materials.

- Delete the first three paragraphs.
- In fourth paragraph, delete “aluminum sheet material”. Replace with “louvered aluminum backplates”.
- At the end of the fifth paragraph, add “Retroreflective sheeting shall be 2 inches wide and attached to the front perimeter of the backplate. Retroreflective sheeting shall be fluorescent yellow.”

740.02. Finish. After “Ensure the backplate is” add “flat”.

801.01. Description. Delete the second paragraph. Replace with the following:

“The contractor shall obtain the necessary permits for electrical inspection on all signal and lighting work. Electrical inspections shall include all electrical equipment, enclosures, devices, cables, conductors and raceways as defined by the NEC. High or low voltage shall be installed, maintained, connected or removed by a State of Oklahoma licensed Electrical contractor. All work shall meet the requirements of the NEC. The City of Tulsa shall reserve the right to define workmanlike manner. Proof of license shall be carried on person at all times and be available to City of Tulsa personnel upon request per Title 158- Construction Industries Board Chapter -40 Subchapter 11-2(a)(9). The Contractor shall contact City of Tulsa Traffic Operations to obtain the address needed to obtain the permit.”

801.04.A. General. Replace all references to “60-cycle” with “60 hertz”.

802. Electrical Conduit. Delete section.

803. Pull Boxes and Ground Boxes. Delete section.

804. Concrete Footings. Delete section.

805. Removal of Traffic Items. Delete section.

806. Poles and Mast Arms. Delete section.

807.02. Materials. In the second sentence of the second paragraph, replace “plastic” with “hardened, tamper-proof”.

807.06. Basis of Payment. In the last paragraph, replace “plastic” with “hardened, tamper-proof”.

809. Luminaires. Delete section.

810. Power Supplies. Delete section.

811. Electrical Conductors Highway Lighting. Delete section.

813.02. Materials. In the first two sentences of the first paragraph, after “(2) hardcopies” add “and one (1) electronic (pdf) copy”.

813.02.A. Structural Design.

- In the second sentence of the first paragraph, delete “corrosion-resistant (stainless or galvanized steel, or aluminum)”. Replace with “galvanized steel”.
- In the eighth paragraph, after “Provide the following luminaire ring suspensions as required by the Contract:”, add “(Only top latching systems are allowed.)”.

813.04. Construction Methods. In the first paragraph, delete the third sentence and replace with “Submit to the Resident Engineer one (1) electronic (pdf) copy and at least five (5) hardcopies per project or one (1) copy per device.”

825. Traffic Signal Controller Assembly. Delete section.

827. Solid-State Flashing Controller. Delete section.

828. Vehicle Loop Detector and Loop Detector Wire. Delete section.

830. Pedestrian Push Button. Delete section.

831. Traffic Signal Heads. Delete section.

832. Optically Programmed Adjustable Traffic Signal Heads. Delete section.

833. Traffic Signal Backplates. Delete section.

834. Electrical Conductors for Traffic Signals. Delete section.

850. Signs. Delete section.

851. Galvanized Steel Sign Posts. Delete section.

855.04.B. Application of Markings. At the end of the first paragraph, add "Remove temporary markings and reflective tabs prior to installing permanent markings."

856. Traffic Stripe (Multi-Polymer). Delete section.

858.04. Construction Methods. At the end of the second sentence of the first paragraph, delete "maker", and replace with "marker".

880.02.B.(5). Warning Lights. In the first sentence, delete "6F-70F", and replace with "6F.83".

880.05.B. Lump Sum Pay Item. At the beginning of the second paragraph, revise "If additional and compensation" to recite "If additional compensation".

Section 2. REPEAL OF CONFLICTING ORDINANCES. That all other ordinances or parts of ordinances in conflict herewith be and the same are now expressly repealed.

Section 3. SEVERABILITY. If any section, subsection, paragraph, subparagraph, sentence, clause or phrase of this ordinance shall be declared invalid for any reason whatsoever, such decision shall not affect the remaining portions of this ordinance, which shall remain in full force and effect, and to this end the provisions of this ordinance are hereby declared to be severable.

Section 4. EFFECTIVE DATE. This ordinance shall be effective on July 1, 2021.

JUN 02 2021

ADOPTED by the Council: _____
Date

Chair of the Council

OFFICE OF THE MAYOR

Received by the Mayor: _____ at _____
Date Time

G.T. Bynum, Mayor

By: _____
Secretary

APPROVED by the Mayor of the City of Tulsa, Oklahoma: JUN 09 2021

Date

at _____

Time



Mayor

ATTEST:





City Clerk

APPROVED:



City Attorney

OK-JMS

SPECIFICATIONS

- A. Oklahoma Department of Transportation Standard Specifications for Highway Construction, 2019 Edition as modified by Ordinance 24616, shall be used on this project including Section 100-General Provisions.

- B. City of Tulsa, Public Work, Engineering Division, Construction Specifications – March 2022 are incorporated herein as if fully set forth and are on file, including all revisions posted on internet prior to bid opening, with the Public Works Department, Engineering Division, 175 E. 2nd Street, Tulsa, Oklahoma or access on the internet at:
<https://www.cityoftulsa.org/government/departments/public-works/engineering-services/specifications-checklists-and-details/>

SPECIAL
PROVISIONS

SPECIAL PROVISION
SUPPLEMENTAL CONTRACT REQUIREMENTS
PROJECT NO. 2026-MPO C3
NON-ARTERIAL MILL, PATCH & OVERLAY MAINTENANCE ZONE 6042

1. Apparent lowest, responsible bidder shall return their signed contract documents (including bonds and insurance) to the City of Tulsa, Contract Administration Section 175 E. 2nd Street, 13th Floor, OK 74103 within fifteen (15) days after notification by the City.
2. If the apparent lowest, responsible bidder provides their signed contract documents (including bonds and insurance) and the contract is executed by the City, the Pre-Construction Conference for this project will be held within sixty (60) days after bid opening.
3. The Notice to Proceed or written work order (NTP) will be issued in the normal time period (approximately within ten (10) days of the Pre-Construction Conference).

The City will grant up to **Zero (0) days** for a delayed (flexed) NTP after the Pre-Construction Conference. No delayed (flexed) NTP above this amount will be granted unless approved by the City Engineer or designee.

4. There will be no additional compensation due to the use of a delayed (flexed) NTP.
5. This Special Provision does not alter the Public Meeting requirements (and public notice) defined in the General Conditions.

SPECIAL PROVISIONS
INSURANCE REQUIREMENTS

In reference to Ordinance No. 24616 Adoption of State Specification for Highway Construction, Section 107.12 shall be modified as follows:

The CONTRACTOR (and any subcontractors) shall carry and keep in force during this Contract, policies of insurance issued by an insurer authorized to transact business in Oklahoma in minimum amounts as set forth below or as required by the laws of the State of Oklahoma. The CONTRACTOR shall also furnish an Owner's Protective Policy in the same amounts naming the City of Tulsa as the assured, issued by the same insurance company as the CONTRACTOR'S liability coverage and indemnifying the City of Tulsa against any and all actions, claims, judgments or demands arising from injuries of any kind and character sustained by any person or persons because of work performed by the CONTRACTOR.

General Liability Insurance with a bodily injury and property damage combined single limit of not less than \$1,000,000.00 for each occurrence.

Employer's Liability and Workmen's Compensation in the amounts as required by law.

The CONTRACTOR shall provide proof of such coverage:

- (a) By providing Certificate(s) of Insurance prior to the execution of this contract; and
- (b) By submitting updated Certificate(s) of Insurance with each and every subsequent request for payment. The Certificate(s) should show that the policies are current and should be dated within 30 days of payment request.

The CONTRACTOR shall not cause any required insurance policy to be cancelled or permit it to lapse. If the CONTRACTOR cancels, allows to lapse, fails to renew or in any way fails to keep any required insurance policy in effect, the City will suspend all progress and/or final payments for the project until the required insurance is obtained. Further, a CONTRACTOR who fails to keep required insurance policies in effect may be deemed by the City to be in breach of contract, ineligible to bid on future projects, and/or ineligible to engage in any new contracts.

The Contractor shall execute and furnish a Statutory Bond for the protection of laborers, mechanics, and material men in a sum equal to one hundred percent (100%) of the contract price.

The Contractor shall execute and furnish a Performance Bond in a sum equal to one hundred percent (100%) of the contract price.

The Contractor shall execute and furnish a Maintenance Bond in a sum equal to one hundred percent (100%) of the contract price.

Prior to doing blasting, the Contractor shall furnish a Certificate of Insurance, which shall certify that any damage caused by blasting is within the coverage of the Contractor's liability insurance to the full limits thereof.

All bonds and insurance must be executed by a company licensed to do business in the State of Oklahoma and must be acceptable to the City.

SPECIAL PROVISIONS GENERAL

1. Workdays: All work to be completed within **120 calendar days** for the Base Bid.
2. No work shall be done between the hours of 7:00 p.m. and 7:00 a.m., nor on Saturday, Sunday, or legal holidays without the prior written approval or permission from the City of Tulsa, except such work as may be necessary for the proper care, maintenance, and protection of work already done, or of equipment, or in the case of an emergency.
3. Traffic Control: **All temporary traffic control shall be in accordance with Part 6 of the Manual of Uniform Traffic Control Devices (MUTCD)**. All work shall be done in cooperation with the City to establish, install, maintain and operate a complete, adequate and safe traffic control plan during the entire construction period and the prompt removal of the traffic control from the construction site upon completion of a street. **Failure to properly maintain traffic control devices on or adjacent to Arterial Streets during construction will subject the Contractor to Liquidated Damages of \$500.00 per day for each calendar day that the traffic control devices are NOT adjusted, properly maintained and/or removed from a street and/or construction site once paving operations have been completed.** Barricades, signs, lights, flags and all other traffic control devices shall meet the requirements and specifications of the Standard Drawings entitled "Typical Applications of Traffic Control Devices" and, shall be approved by the Traffic Engineer of the City of Tulsa. Two-way traffic shall always be maintained, unless otherwise approved by the Traffic Engineer. All contractors shall contact the City of Tulsa Traffic Operations Division before removing or replacing traffic devices, detector loops and street signs. A traffic plan must be submitted for any temporary street closure at least 2 working days prior to planned closing.
4. Contractor shall provide an acceptable 10' straightedge for this Project. All transverse joints shall be straight edged and approved by the Engineer. Surface elevation will meet ODOT 401.04 and all other contract requirements.
5. The Engineer may do quality assurance testing in addition to that performed by the Contractor. The Engineer or a testing laboratory designated by the Engineer will do any testing for quality assurance. The City will pay all costs of quality assurance.
6. Full depth sawing of patches is required. This area to be removed shall be marked by the Contractor under the direction of the Engineer. The Contractor will provide personnel and equipment for marking of the patches as directed by the Engineer. Cost of full depth sawing shall be included in bid item for patching areas.
7. Areas to be patched shall be delineated in a straight-line geometric pattern. When completed, the patch shall be level and provide a smooth riding surface. Portland Cement Concrete patches will be protected from all traffic for a minimum period of 24 hours before removal of protective devices. No open excavations will be left overnight.

8. All asphalt patch work will require that asphalt rollers and an asphalt laydown machine be available for use on the job as directed by the Engineer.
9. Contractor will be required to employ the use of an Automatic Grade Referencing System. The equipment shall be capable of accurately and automatically establishing grades along each edge of the machine by referencing the existing pavement by means of a ski or joint matching shoe, or from an independent grade control. Minimum length of ski shall be 40'.
10. Prior to application of tack coat, the street shall be blown clean with compressed air to the satisfaction of the Engineer.
11. The tack coat must be uniformly distributed and adequately cured prior to beginning the overlay.
12. Contractor shall be responsible for cleanup and/or removal of any excessive over spray of any tack coat material to the satisfaction of the Engineer.
13. Debris from routing of cracks and cold milling shall be swept and vacuumed from the street to the satisfaction of the Engineer.
14. Contractor will be responsible for preparation and distribution of a written notice to residents within 48 hours of beginning milling and overlay operations. Costs associated with this requirement will be included in other items of work.
15. Contractor shall provide a continuous work effort towards total completion of the work in an area prior to moving to a different location.
16. All full depth asphalt patches will be made only after milling is complete, if milling is required, and prior to overlay.
17. No masonry structures shall be used in street right of way. Either precast or cast-in-place structures shall be used.
18. No lifting holes will be allowed in any reinforced concrete pipes or reinforced concrete boxes.
19. No fly ash is allowed on this project.
20. The Contractor certifies that it and all its Subcontractors to be used in the performance of the Contract are in compliance with 25 O.S. Sec. 1313 and participate in the Status Verification System. The Status Verification System is defined in 25 O. S. Sec. 1312 and includes but is not limited to the free Employee Verification Program (E-Verify) available at www.dhs.gov/E-Verify.

21. **Driveways.** Access to properties and businesses adjacent to the right of way must always be provided and maintained unless otherwise directed/approved by the Engineer. The Contractor will contact the business or property owner at least 5 days in advance of any driveway closure. Driveways and patches in front of driveways, which are removed, shall not be left unusable overnight. If concrete cannot be placed the same day as removal, the Contractor shall furnish screening or other suitable aggregate material to maintain temporary access until concrete can be placed. The cost of placing and removing the material for temporary access shall be included in the pay item for Concrete Driveway (High Early Strength). **Failure to leave any driveway usable will subject the Contractor to a \$1000.00 per day fine for each calendar day that the driveway remains non-useable.** The only exception for a driveway to be non-useable is to allow for curing time for concrete. Cure time will not exceed 48 hours.
22. Driveways more than 18-feet in width shall be constructed in half-sections and access shall always be maintained.
23. Contractor shall prepare and present a schedule and plan for lane and driveway closures throughout the project. The Contractor shall include in the plan, driveway signage for local business access. Payment for signs will be included under the pay item "**Signage for Local Business Access**" and will be paid for by the square foot. Coordination with the City of Tulsa and local business operators shall be required before a driveway schedule and plan is approved.
24. Contractor shall coordinate with the City of Tulsa and local business operators to identify opportunities to perform weekend or "after business hours" construction on driveways to minimize impacts to the area.
25. Local and through traffic shall always be maintained through the project unless otherwise permitted by the Engineer. All public and private streets shall always be accessible. All detours, horizontal traffic movements, etc. are directly related to the sequence of work; therefore, the Contractor shall proceed with his construction operation in conformity with the details shown on the plans and as required by this special provision.
26. Traffic must be handled appropriately through the entire project during construction and it shall always be the responsibility of the Contractor to provide for the safety and comfort of the traveling public. The Contractor shall be required to give the traveling public at least **48 hours** advance notice of any lane and/or street closures.

27. The Contractor may propose/recommend modifications to the sequence of work for consideration by the Engineer. Any major recommended modification by the contractor shall include any changes to the various pay items, impact to traffic, and effect of overall project in time and cost, etc. The Contractor shall not proceed with any construction operations based on a revised phase/sequence until the Contractor obtains written approval from the Engineer.
28. Two lanes shall remain open to traffic, one in each direction, throughout all phases of construction, unless otherwise approved/directed by the Engineer. Left turn lanes shall remain open to traffic throughout all phases of construction, unless otherwise approved/directed by the Engineer. Transitions from pavement elevations through construction areas to access driveways or intersections shall be the Contractor's responsibility. Contractor shall maintain signs and markings on a continuous basis.
29. The Contractor shall submit to the City of Tulsa for approval, prior to paving, a detailed paving operation plan with a schedule indicating sequence of streets to be paved and paving passes, pass widths, pass thicknesses. The paving plan shall also include dates for each street to be paved.
30. The Contractor shall submit to the City of Tulsa in connection with their paving plan, a planned striping sequencing schedule. The striping schedule shall include the dates for each street to be striped per the paving plan. Once paving operations are complete on a street, that street shall be scheduled for striping within one week of completion of paving.
31. Striping shall be complete on a street within two weeks. **Failure to have striping complete on a street per the striping schedule will subject the Contractor to \$1000.00 per day in liquidated damages each calendar day that street remains incomplete of striping. Upon the third week that the street remains incomplete of striping, liquidated damages will increase to \$2000.00 per day each calendar day that street remains unstriped.** It shall be noted that liquidated damages shall be implemented per street that is listed within the limits of this project/contract.

SPECIAL PROVISIONS
TIME FOR COMPLETION

1. The work shall commence within ten days from and after the date of a written work order from the City. The Contractor agrees that the work shall be prosecuted regularly, diligently and uninterruptedly at a uniform rate of progress to ensure completion within the number of days after the day on which the work order is issued. If the Contractor shall fail to complete all work within the time specified, then the Contractor agrees to pay the City, not as a penalty, but as liquidated damages for Breach of Contract, the Sum of **Two Thousand Five Hundred Dollars (\$2,500.00)** for each calendar day for failure to complete all work within the time specified. The said amount is fixed and agreed upon because of the impracticability and extreme difficulty of fixing and ascertaining the actual damages the City would in such event sustain. It is expressly understood and agreed that the said time for completion of the work described herein is a reasonable time for the completion of same.
2. If the Contractor shall fail to complete reconstruction of a segment of roadway within **thirty (30)** days of beginning the reconstruction operation, then the Contractor agrees to pay the City, not as a penalty, but as liquidated damages for such breach of contract, the sum of **Two Thousand Five Hundred Dollars (\$2,500.00)** for each and every calendar day of failure to complete the work after the specified time. The said amount is fixed and agreed upon because of the impracticability and extreme difficulty of fixing and ascertaining the actual damages the City would in such event sustain. This time constraint applies only to roadways to be reconstructed and includes all subsidiary work items required to complete the reconstruction. Subsidiary items not required to complete the reconstruction are not subject to this time constraint.
3. If the Contractor shall fail to complete overlaying of any separately milled segment of roadway within **ten (10)** days of beginning the milling operation, then the Contractor agrees to pay the City, not as a penalty, but as liquidated damages for such breach of contract, the sum of **Two Thousand Five Hundred Dollars (\$2,500.00)** for each and every calendar day of failure to complete the work after the specified time. The said amount is fixed and agreed upon because of the impracticability and extreme difficulty of fixing and ascertaining the actual damages the City would in such event sustain. The City will authorize when milling is to be done based on weather conditions. This time constraint applies only to segments to be milled and includes all subsidiary work items required to complete the overlay. Subsidiary items not required to complete the overlay are not subject to this time constraint.
4. The Contractor shall commence work within 24 hours of traffic control devices being established at the project location. If the Contractor shall fail to commence work within 24 hours of traffic control devices being established at the project

Location, then the Contractor agrees to pay the City, not as a penalty, but as liquidated damages for such breach of contract, the sum of **One Thousand Dollars (\$1000.00)** per lane for each day of failure to commence work after the specified time set forth. The amount is fixed and agreed upon because of the impracticability and extreme difficulty of fixing and ascertaining the actual damage the City would in such event sustain.

5. **Within 14 days** after Bid Opening and prior to Award of Bid the successful Contractor will be required to furnish the Engineer with a progress schedule, in a format approved by the Engineer, setting forth in detail the procedure he proposes to follow, and giving the dates on which, he expects to start and to complete separate portions of the work. If at any time, in the opinion of the Engineer, proper progress is not being maintained, such changes shall be made in the schedule of operations, which will satisfy the Engineer that the work will be completed within the period stated in the Proposal. Monthly progress meetings will be conducted to maintain coordination between all project entities.
6. The Contractor will be required to provide a full-time, onsite English-speaking superintendent for this Project for direct contact with City and coordination of subcontractors. A working foreman is not acceptable as a project superintendent. The superintendent shall be required to be present at the work site whenever the Contractor or subcontractors are performing work. The superintendent shall be a representative of the Contractor with the authority to make decision. If the Contractor shall fail to provide a non-working superintendent on a day when work is being performed, then the Contractor agrees to pay the City, not as a penalty, but as liquidated damages for such breach of contract, the sum of **One Thousand Dollars (\$1000.00)** for each calendar day of failure to provide a non-working superintendent at the work site. The said amount is fixed and agreed upon because of the impracticability and extreme difficulty of fixing and ascertaining the actual damages the City would in such event sustain.
7. It is further agreed that time is of the essence of each portion of this Contract and the specifications wherein a definite and certain time is fixed for the performance of any act whatsoever; and where under the contract an allowance of additional time for completion of any work is made, the new time fixed by such extension shall be of the essence of this Contract.
8. Should the Contractor be delayed in the final completion of the work by any act or neglect of the City of Tulsa, or of any employees of either, or by strikes, injunctions, fire or other cause or causes outside of and beyond the control of the Contractor and which, in the opinion of the Engineer, could have been neither anticipated or avoided, then an extension of time sufficient to compensate for the delay as determined by the Engineer, shall be granted by the City, provided however, that the Contractor shall give the City and the Engineer notice in writing

of the cause of the delay in each case on the Extension of Time Request Form enclosed in these documents and agrees that any such claim shall be fully compensated for by an extension of time to complete performance of the work included herein.

9. The Contractor shall submit the Extension of Time Request Form with each partial payment application. Failure to submit the Extension of Time Request with a partial payment application shall constitute a complete waiver of any claim for time extension for the period covered by the partial payment.
10. Extension of time may be granted for delays caused by unsuitable weather. Extension of time will not be granted for delays caused by ground condition, inadequate construction force or the failure of the Contractor to place orders for equipment or materials a sufficient time in advance to ensure delivery when needed. Any extension of time by the City shall not release the Contractor and surety herein from the payment of liquidated damages for a period of time not included in the original contract or the time extension as herein provided. **“Extension of Contract Time will not be granted if conditions exist such that the Contractor could work at least 4 hours.”**
11. Failure to complete project within specified time, as set forth in the Contract, may be grounds for disqualification for future consideration for contracts with the City of Tulsa.
12. Final Acceptance of the Project will be in strict accordance with ODOT Specification 105.17– Project Completion and Acceptance and ODOT Specification 104.10– Final Cleaning Up and defined as “The date on which the Request for Action (RFA) for final payment has been signed by the Mayor of the City of Tulsa.”
13. Contract Evaluation forms will be compiled by City staff upon completion of this Project to provide a record of the Contractor's performance for use in subsequent projects.

SPECIAL PROVISIONS
FOR ADJUSTMENT OF ROADWAY UTILITIES

1. Contractor is to remove the rings and covers of manholes and water valves and the frames and grates of single grate drop inlets and double grate drop inlets. If these items are to be reused, the Contractor is to mark, store and protect these materials for later placement in the exact orientation existing at the beginning of the Project. After removal of these obstructions, the Contractor shall place over each hole 5/8" thick steel plate cut to the proper size as directed by the Engineer. After placement of steel plate, the hole shall be filled with compacted asphalt to the established street grade. It shall be the Contractor's responsibility to make the necessary measurements to ensure that all utilities can be easily located after overlay. After the overlay the Contractor shall raise the utilities to the new grade.
2. Manholes and inlet basins shall be raised or lowered as required by using a solid, continuous layer of bricks and mortar. The upper portion of manhole or basin shall be removed as required for correct raising or lowering adjustment. If existing basin or manhole walls are concrete, the Contractor may dowl apron into wall in lieu of removing the upper portion of wall. Dowels shall be #4, at 1' - 0" O.C. grade 60 steel.
3. All existing I-beams on double or triple grate frames shall be re-established under grates.
4. Where basins or manholes are covered for construction or other purposes, curbs shall be marked with green paint.
5. Silicone construction joint material per Public Works Standards shall be used where concrete aprons meet existing or new concrete pavement. Bituminous construction joint material per Public Works Standards shall be used where concrete aprons meet existing or new asphalt pavement.
6. The Contractor shall place a minimum 1/2" thick flexible gasket bitumastic sealant material in two concentric rings, along the inside and outside edge of the top of the manhole prior to reinstalling the frame. The gasket shall be E-Z STIK Butyl Rubber Sealant, PRO-STIK Performed Joint Sealant or equal. The material shall be able to withstand hydrogen sulfide and other corrosive gasses. After the frame has been set, a normal 1/2 coat of trowelable bitumastic joint sealant shall be applied to the entire outside circumference of the manhole. The sealant shall be applied from the top of the lower flange down a minimum of 6" below the frame connection. It shall then be wrapped with a 6 mil plastic to protect against damage from backfill. The trowelable material shall be Joint Mastic Sewer Joint Compound or equal. The cost of the material and labor associated with installing it shall be included in the price bid for manholes, adjust to grade.

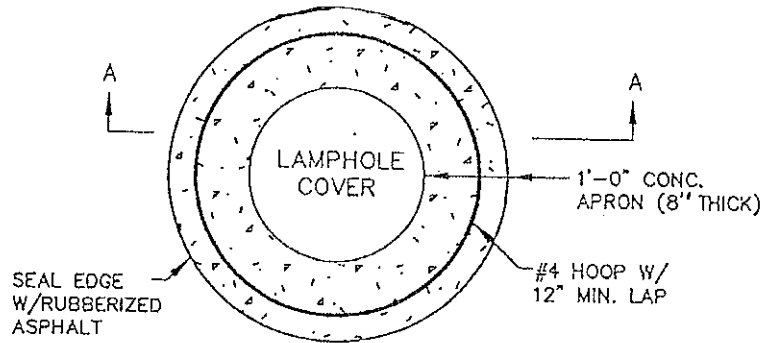

PLAN VIEW

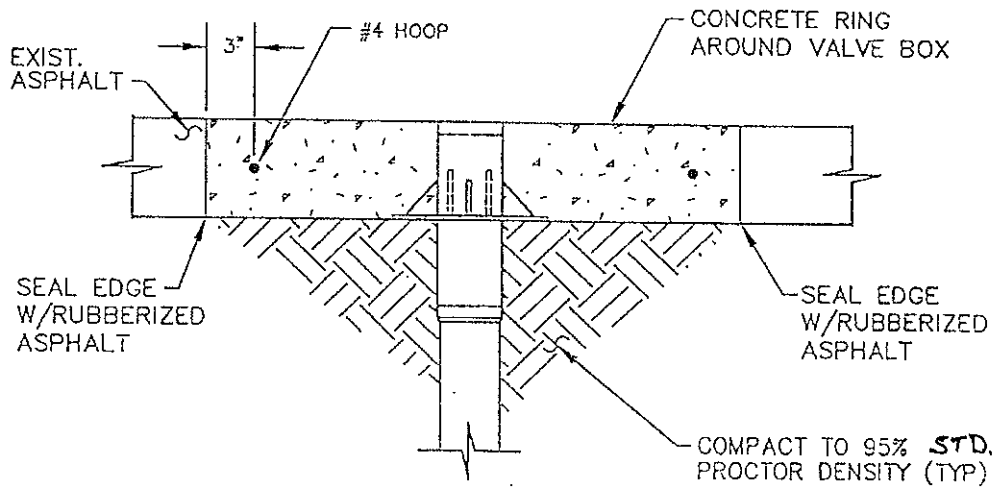

SECTION A

LAMPHOLES IN ASPHALT
ADJUST TO GRADE

N.T.S.

8/30/05

ARU-2

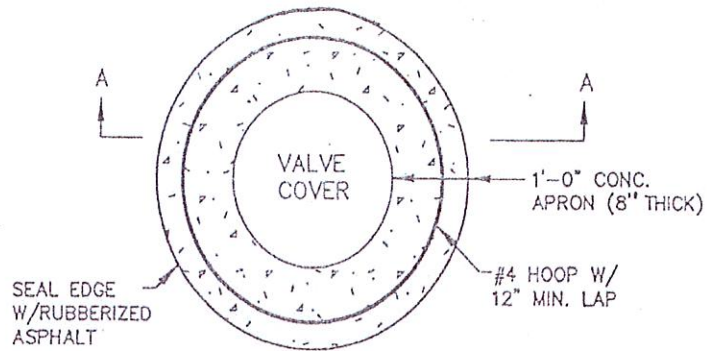

PLAN VIEW

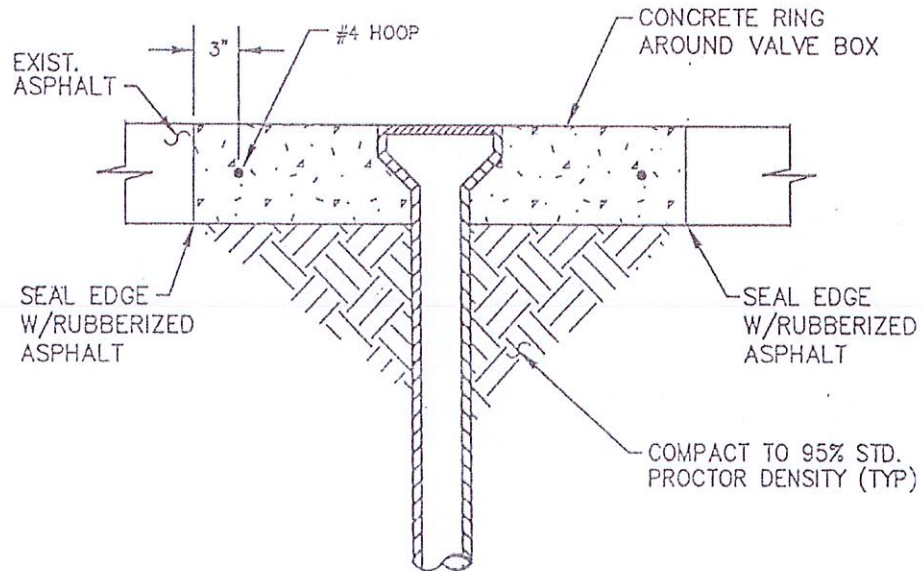

SECTION A

WATER VALVES TO GRADE
IN ASPHALT STREET

N.T.S.

3/30/05

SPECIAL PROVISIONS
FOR COLD MILLING BITUMINOUS PAVEMENT

1. Contractor will perform milling operation in accordance with ODOT Specifications as stated in Section 417.
2. Contractor will be required to perform the following as a minimum:
3. Milling of Asphalt Pavement per Specifications and Special Provision.
4. Provide all Traffic Control per Specifications and Special Provision.
5. Load and haul milled material are the ownership of the contractor.
6. Clean-up Milling Operation as directed by Engineer. This will include removal of unbonded asphalt overlays and sweeping.
7. All streets designated for milling shall be milled as shown on typical sections. If street is full depth Asphalt the depth of cut shall be as specified for each segment. If street is concrete with an Asphalt Overlay then all existing asphalt shall be removed. Boring logs are included as Appendix A. No payment will be made for any additional passes necessary to remove asphalt to the required cross section. Care should be exercised not to mill into the underlying concrete pavement. The Contractor will be responsible for damage to concrete caused by excessive milling.
8. The Contractor shall provide a power operated milling machine capable of planing a minimum depth of three inches in a single pass. The equipment shall be self-propelled with sufficient power, traction and stability to maintain accurate depth of cut and slope. The equipment shall be capable of accurately and automatically establishing profile grades along each edge of the machine by referencing the existing pavement by means of a ski, or matching shoe or from an independent grade control, and shall have an automatic system for controlling cross slope at a given rate. The machine shall be equipped with an integral loading means to remove the material being cut from the pavement surface and to discharge the cuttings into a truck, all in a single operation.
9. Milled material to become property of City of Tulsa.
10. The Contractor shall provide butt joints as directed by the Engineer. Wherever the planned overlay of an asphalt street meets existing pavement, or at the end of a paving run, butt joints shall be provided to a depth matching the planned overlay thickness. The transition shall extend a minimum of 10 feet longitudinally from the joint for residential streets and a sufficient length to provide a smooth riding surface for arterial streets. Butt joints will not be paid for directly, but the cost shall be included in the price bid for milling.

11. Entrance and Exit Areas to projects:

12. After an entrance or exit area has been milled, the Contractor shall construct access ramps. These ramps shall be a minimum of 20' in length and shall be placed across full width of street. These ramps shall be maintained by Contractor and shall remain in place until lanes are closed for overlay. Ramps will be provided at driveways and non-arterial streets as needed to maintain a smooth transition for abutting properties during construction. Ramps will not be paid for directly, but the cost shall be included in the price bid for milling.

13. The existing pavement shall be uniformly milled to provide a uniform texture, true to line, grade and cross section; it shall have no deviations in excess of 3/16 inch in ten feet. Any portion of the planed surface not meeting this requirement shall be corrected in a manner approved by the Engineer.

CMBP-2

11/13/2024

SPECIAL PROVISIONS
FOR SPECIAL SPECIFICATION
OF HIGH EARLY STRENGTH CONCRETE

DESCRIPTION

This work shall consist of furnishing and placing, High Early Strength Concrete.

MATERIALS

High Early Strength Concrete shall conform to Section 701, Portland Cement Concrete, of the Oklahoma Department of Transportation (ODOT) Standard Specification for Highway Construction, Current Edition, with the following modifications:

Air Content	-	5-7 percent
Maximum Water - Cement Ratio	-	0.41
Slump	-	1-3 inches

Batching shall measure the weights of each material required within a tolerance of one percent for cement and two percent for aggregates (account for moisture content). The quantity of water used shall be within plus or minus one percent of that required by the design. Water may be measured either by volume or by weight. All materials shall be used in strict accordance with the manufacturer's recommendations.

Submittals shall be delivered to the City of Tulsa at a date set by the Engineer. Submittals shall include the items outlined in ODOT Specification 701.03.

CONSTRUCTION METHODS

The concrete shall be mixed between 70 to 100 revolutions of the ready-mix truck. Mixing shall be in a mechanical mixer capable of combining the aggregates, cement, and water into a thoroughly mixed and uniform mass within the manufacturer's specified mixing period. There shall be no water in the mixing drum prior to adding the aggregates.

TESTING

Following are the testing requirements for the High Early Strength Concrete mix:

Compressive Strength: ¹	2,500 pounds per square inch (psi) – 12 hours 3,000 psi – 24 hours
Slump:	1 inch minimum 3 inches maximum
Air Content:	5-7 percent

¹ During cool weather (less than 50 degrees Fahrenheit), specimens shall be cured in a fully insulated closed box.

During moderate weather (between 50°F and 80°F), specimens shall be cured in both open and fully insulated closed boxes with compressive strength tests performed on specimens from each curing box.

During warm weather (greater than 80°F), specimens shall be cured in a closed box placed in a shaded area.

**SPECIAL PROVISIONS
FOR HOT MIX ASPHALT**

DESCRIPTION

This work shall consist of furnishing and placing Hot Mix Asphalt.

MATERIALS

Hot Mix Asphalt shall conform to Section 708, Plant Mix Bituminous Bases and Surfaces, of the Oklahoma Department of Transportation (ODOT) Standard Specification for Highway Construction, Current Edition, with the following modifications to Table 5A:

	A	B	C
Asphalt Cement % of mix mass (greater than or equal to)	5.0	6.0	6.0

Submittals shall be delivered to the City of Tulsa at a date set by the Engineer. Submittals shall include the test results of the physical properties of the aggregate and asphalt cement as outlined in ODOT Specification 708.

The **SPECIAL PROVISION**
MINIMUM ASPHALT RETAINED STRENGTH

This Special Provision revises, amends, and where in conflict, supersedes applicable sections of the 1999 Oklahoma Department of Transportation Standard Specifications for Highway Construction, (ODOT).

The "% Retained Strength, min." for asphalt as listed in ODOT Section 708 TABLE 6A "PROPERTIES OF LABORATORY MOLDED SPECIMENS" shall be 80%.

SPECIAL PROVISIONS
OWNER ALLOWANCE

The "Owner Allowance" may be used for various work and miscellaneous items not specifically identified in the Contract Documents with the following provisions:

- A. The allowance shall be used for cost of design and construction, including all materials, labor, equipment, profit and overhead, of work items not specifically identified in the Construction Documents, or included in original pay items bid for the contract.
- B. The allowance shall be utilized only at the discretion of the City of Tulsa. Any balance remaining at the completion of the Project will be retained by the City of Tulsa.
- C. The Contractor shall provide, to the City of Tulsa, a written request for the use of any allowance, including a schedule of values and associated backup information, including validity of need, materials, labor, equipment, and time required to perform the associated work.

Contractor shall proceed with the allowance work only after receiving written permission from the City of Tulsa. Proceeding with associated allowance work without written permission from the City of Tulsa will be at the Contractor's sole expense.

SPECIAL PROVISIONS
FOR PATCHING OF CONCRETE AND ASPHALT STREETS

The City of Tulsa Standards for street cut and repair shall be followed for materials and procedures except as modified here.

Patching

Instructions: Portland Cement concrete patches will be protected from all traffic for a period of 24 hours before removal of protective devices. Sawing of the patches is required. The area to be removed shall be marked by the Contractor under the direction of the Resident Inspector. The Contractor will provide personnel and equipment for making of patches as directed by Resident Inspector. When completed, the patch shall be level and provide a smooth riding surface. All asphalt patch work will require that asphalt rollers and an asphalt laydown machine be available for use on the job as directed by the engineer. The minimum size of any patch shall be 3' x 3'.

Testing of

Materials: The frequency of testing shall be as follows:

Subgrade Compaction: A minimum of one (1) density test of the subgrade shall be done per patch.

Concrete: Three cylinders shall be taken from every 50 cubic yards of concrete and tested for compressive strength.

Asphalt: Compaction and extraction tests shall be taken a minimum of every 50 tons of asphalt.

Weather

Limitations: The minimum temperature of the foundation course on which asphalt concrete may be laid shall be as shown in the following table:

Compacted Lift Thickness (inches)	Surface Temperature (minimum)
3 or more	40° F
1 ½ to 3	45° F
less than 1 ½	50° F

Asphalt

Materials: All asphaltic concrete used for this Project shall meet the specifications of ODOT Section 708. Under the paragraph, "Course Aggregates", the following sentence shall be added: When tested for soundness, the number of cycles shall be five (5), the solution shall be Na₂ SO, the maximum loss shall be 10%.

Type I Patch
Subgrade

Replacement: Shall consist of the removal of subgrade material as measured from the bottom of the existing pavement. The removed subgrade material shall be replaced with separator fabric meeting the requirement of ODOT Section 325 and aggregate material meeting the requirement of ODOT Section 703.01 Type "A". The existing subgrade shall be compacted to 95% standard proctor density per AASHTO T-99 and the aggregate material shall be compacted to 98% modified proctor density per AASHTO T-180-86 Method as measured by the Nuclear Density Method. Compaction shall be done with a roller or vibratory hand tamper. Certain situations may require substitution of Quick-set Fill Concrete for aggregate material. Fill concrete specifications are shown on the Standards for Pavement Cut and Repair. Separator fabric shall be used at all full depth pavement patches where aggregate base is required, as directed by the Engineer. The fabric shall be cut or overlapped to fit the size of the patch. These items will be paid separately from the bid item for patching.

Type A Aggregate

Base: This material shall have the following gradation, which is ODOT Section 703-01 Type "A".

<u>Sieve (mm)</u>	<u>% Passing</u>
1 ½ in. (37.5)	100
¾ in. (19.0)	40 – 100
3/8 in. (9.5)	30 – 75
No. 4 (4.75)	25 – 60
No. 10 (2.00)	20 – 43
No. 40 (0.425)	8 – 26
No. 200 (0.075)	4 – 12

Type I Patch
in PCC

Pavement: When the patch is made in PCC, the pavement shall be cut with a concrete saw full depth before removal of existing pavement. The area to be patched shall be delineated in a straight-line geometric pattern. Placement of the subgrade stabilization material shall be in accordance with the paragraph; "Type I Patch Subgrade Replacement". After placement of the subgrade stabilization, the pavement shall be replaced with Class A High Early Strength concrete containing 4 to 6 percent air entrainment. The concrete shall have a maximum 3" slump. The concrete shall be placed in accordance with the detail in the drawings titled "Type I PCC Patch". The new concrete shall have a flat finish and match the grade of the adjacent pavement.

Existing joint patterns shall be reestablished and sealed as specified. The concrete shall be sprayed with curing compound and protected from traffic a minimum of 24 hours. Cold Joints around the perimeter of the patch shall be sawed and sealed with silicone in accordance with ODOT specification 701.08(E). All sawing, pavement removal, and sealing costs shall be included in the bid item for patching, H.E.S. concrete.

Type I Patch in Asphalt

Pavement: When the patch is made in asphalt, the pavement shall be cut with a concrete saw full depth before removal of existing pavement. The area to be patched shall be delineated in a straight-line geometric pattern. Placement of the subgrade stabilization material shall be in accordance with the paragraph; "Type I Patch Subgrade Replacement". After placement of the subgrade stabilization material, the pavement shall be replaced in accordance with the detail in the drawings titled "Type I AC Patch", a minimum of 8" or existing paving thickness, whichever is greater. All asphalt materials shall meet the specifications of ODOT 708 Plant Mix Bituminous Bases and Surface. The asphalt shall be placed and compacted in maximum 3" lifts. The edges of the patch shall be tacked prior to the placement of asphalt. The asphalt shall be compacted to 92% minimum density as determined by AASHTO T-209 Method. The patch shall be stringlined as required and all areas not matching the adjacent grade shall be immediately corrected. Cold joints around the perimeter of the patch shall be sawed and sealed with rubberized asphalt. All sawing, pavement removal, replacement, and sealing costs shall be included in the bid item for patching, AC.

Type I Patch in APC

Pavements: Patching of PCC pavements with an asphalt overlay shall be performed as follows: Placement of the asphalt portion of the patch shall be in accordance with the paragraph "Type I Patch in Asphalt Pavements". Placement of the PCC portion of the patch shall be in accordance with the paragraph "Type I Patch in PCC Pavements". Placement of the subgrade stabilization material shall be in accordance with the paragraph "Type I Patch Subgrade Replacement". After placement of the subgrade stabilization material, the pavement shall be replaced in accordance with the detail in the drawings titled "Type I APC Patch". Payment will be made separately for each of the three materials: Type "B" AC, H.E.S. PCC and Aggregate Base. Initial sawing,

pavement removal and sealing costs shall be included in the bid items for patching as listed above. Additional sawing required to go from a Type "III" to a Type "I" patch shall be included in the bid items for H.E.S. PCC.

Type II Patch
In APC

text here

Pavement: The asphalt overlay shall be removed prior to sawing through the PCC Pavement to determine if only the asphalt needs to be patched. Sawing of The asphalt is required, but should not penetrate the PCC pavement. If the PCC pavement needs to be replaced, a Type "I" APC patch shall be made. Payment will me made for Type "B" or Type "C" AC only. If only the asphalt is removed, initial sawing, pavement removal, and sealing costs shall be included in the bid items for asphalt concrete.

**SPECIAL PROVISIONS
FOR
PRICE ADJUSTMENT FOR ASPHALT BINDER**

These special provisions revise, amend, and where in conflict, supersede applicable sections of the 2009 Standard Specifications for Highway Construction, English and Metric. *(Add the following:)*

109.12 PRICE ADJUSTMENT FOR ASPHALT BINDER

A price adjustment clause is included in this Contract to provide additional compensation to the Contractor or a credit to the Department for fluctuations in asphalt binder prices. This price adjustment is dependent upon a change in the average price of asphalt binder which results in an increase or decrease in the price of products utilized on this project.

A. Payment

Payment will be made to the Contractor for monthly fluctuation in the price of asphalt binder used in performing the applicable items of Asphalt Concrete work as listed in the table below when the asphalt binder price fluctuates by more than 3% from the base price defined below. Payments may be positive, negative, or nonexistent depending on the circumstances. Payments or deductions will only be calculated on that portion of the asphalt binder price fluctuation that exceeds the 3% specified above. Payments or deductions for the asphalt binder price adjustment will be included in the Contractor's progressive estimates; and the payment or deduction authorized for each estimate will be based upon the algebraic difference between the quantities for applicable items of work.

The Asphalt Binder Price Adjustment will be a dollar amount paid as compensation to the Contractor, or as a credit to the Department as reflected on the Progressive (or Final) Estimate Summary Report as Line Item Adjustments.

B. Asphalt Binder Price Adjustment (ABPA)

The Asphalt Binder Price Adjustment (ABPA) for the current estimate will be computed according to the following formula:

$$ABPA = Q \times F \times D$$

where

ABPA	=	Asphalt binder price adjustment, in dollars;
Q	=	The algebraic difference between the quantities for the applicable items on the current estimate and the quantities shown on the previous estimate, in tons of mix;
F	=	The Asphalt Binder Use Factor for the applicable items of work subject to this price adjustment, as listed in Table 109:1;
D	=	Allowable price differential, in dollars.

Table 109:1 Asphalt Binder Use Factor		
ITEM OF WORK	SPECIFICATION NUMBER	ASPHALT BINDER USE FACTOR PER UNIT (English and Metric units)
Permeable Friction Course	405	0.062 ton of binder per ton of mix
Open Graded Friction Surface Course	406	0.058 ton of binder per ton of mix
Asphalt Concrete, Type S-2	411(A)	0.037 ton of binder per ton of mix
Asphalt Concrete, Type S-3	411(B)	0.042 ton of binder per ton of mix
Asphalt Concrete, Type S-4	411(C)	0.048 ton of binder per ton of mix
Asphalt Concrete, Type S-5	411(D)	0.053 ton of binder per ton of mix
Asphalt Concrete, Type S-6	411(E)	0.058 ton of binder per ton of mix
SMA	411(F)	0.062 ton of binder per ton of mix
Asphalt Concrete, Type RBL	411(G)	0.054 ton of binder per ton of mix
Asphalt Concrete, Type RIL	411(J)	0.054 ton of binder per ton of mix

When the units of measure in this contract for the items of work listed in the table do not correspond with the units shown in the table (i.e. Asphalt Concrete paid by the square yard, etc.), those items will not be subject to the terms of this special provision or any asphalt binder price adjustment.

The allowable price differential, “D”, for the current estimate will be computed according to the following formulas:

When the current price, P, is greater than the base price, P _(b) .
$D = P - [1.03 \times P_{(b)}]$, but not less than zero.
When the current price, P, is less than the base price, P _(b) .
$D = P - [0.97 \times P_{(b)}]$, but not greater than zero.
P, the asphalt binder current price in dollars per ton (mton), is the Monthly Asphalt Binder Price Index for the month in which the estimate pay period ends.
P _(b) , the asphalt binder base price in dollars per ton (mton), is the Monthly Asphalt Binder Price Index for the month in which the bids for the work were received.

The Department will establish the Monthly Asphalt Binder Price Index each month and post the information to the Department website at:

<http://www.okladot.state.ok.us/contractadmin/pdfs/binder-index.pdf>

C. Asphalt Binder Index Determination

The Monthly Asphalt Binder Price Index will be determined by calculating the average of the minimum and maximum prices for performance-graded binder using the Selling Price of PG64-22 paving

1/14/13

grade, as listed under “Midwest/Mid-Continent Markets - MISSOURI/KANSAS/OKLAHOMA - Tulsa, Oklahoma/Southern Kansas”. The publication used to establish each Monthly Asphalt Binder Price Index will be the Asphalt Weekly Monitor® furnished by Poten & Partners, Inc. The issue of the Asphalt Weekly Monitor® used will be for the last full week in the previous month received by the Department prior to the first day of the index month. If the specified publication ceases to be available for any reason, the Department at its discretion will select and begin using a substitute price source or index to establish the Monthly Asphalt Binder Price Index.

D. Supplemental Items Subject to Adjustment

Items included in the contract that are listed in the table above are subject to adjustment in accordance with this provision, regardless of any amount of overrun to the plan quantity. Any new items of work added to the Contract by supplemental agreement that are listed in the table above, will be subject to the asphalt binder price adjustments in accordance with this provision. The base asphalt binder price, $P_{(b)}$, for any newly added eligible items will be the same $P_{(b)}$ as the eligible items in the Contract and the new unit price established by supplemental agreement will be determined accordingly.

SPECIAL PROVISIONS
FOR PAVING OPERATIONS

1. The If the width of a street is such that it exceeds the paver's ability to pave one-half the street width another paver will be required and shall be operated so as to lay asphalt on at least one-half of the street width at a time.
2. The longitudinal joint shall run parallel to the approximate center of the street. Transverse joints shall be kept to a minimum. If it becomes necessary to stop the paving operation short of the end of the job then the two transverse joints shall be no farther apart than 6'.
3. If for any reason the Contractor is unable to pave one-half the width of the street with one paver, paving operations shall cease.
4. A paving plan, indicating sequence of paving passes, pass widths, pass thickness, and requested temporary street closures, will be submitted prior to paving.
5. Once paving begins the Contractor should have sufficient trucks available to deliver asphalt materials in a continuous operation.
6. Adequate transitions to side streets and driveways must be provided. In general, paving shall extend to the returns of all side streets. Special consideration should be given to preventing ponding in side street intersections.
7. The contractor shall provide butt joints as directed by the Engineer. Wherever the planned overlay of an existing street meets existing pavement, or at the end of a paving run, butt joints shall be provided to a depth matching the planned overlay thickness. The transition shall extend a minimum of 10 feet longitudinally from the joint to provide a smooth riding surface. Butt joints will not be paid for directly but the cost shall be included in the cost of the paving operations where they are used.
8. Contractor shall not drive empty or loaded trucks or equipment across newly paved areas for the construction period.
9. A leveling or "wedge" course may be required to establish the required cross-slope for the finished overlay. This item of work will be paid for separately under the bid item designated as Asphalt Concrete Type "S5" in tons.

SPECIAL PROVISIONS
REMOVAL OF CASTINGS

All water, sanitary sewer, and storm sewer manhole castings, lids, frames, curb hoods, grates, hydrants, valves, and other fittings removed as part of any construction project are property of the City of Tulsa. Contractor will not take ownership.

All storm sewer and sanitary sewer castings shall be salvaged and delivered by the contractor to the Underground Collections North Sewer Base Stockyard at 9319 East 42nd Street North. Contractor will coordinate the return of such items with the Stockyard personnel at 918-669-6130.

All hydrants, valves, and other fittings from abandoned water mains shall be salvaged and delivered by the contractor to the South Yard at 2317 South Jackson Avenue. Contractor will coordinate the return of such items with the South Yard personnel at 918-596-9401.

RC-1

SPECIAL PROVISION
FOR UTILITY RELOCATIONS
AND DESIGN ISSUES

It is the intent of this specification to provide no more than seventy-five **(75)** calendar days due to delays caused by required utility relocations and required design clarifications. Should the Contractor be delayed in the final completion of work by any utility relocation or design issue, additional days as determined by the Engineer shall be granted by the City. However, the Contractor shall give the Engineer notice in writing of the cause of the delay in each case on the Extension of Time Request Form enclosed in these documents and agrees that any claim shall be fully compensated for by the provisions of this specification to complete performance of the work. An adjustment will not be made to the contract time bid for incentive purposes.

Any time granted for utility relocations or design issues up to **(75)** calendar days will be in addition to the number of days shown in the proposal for computation of disincentive and liquidated damages.

SPECIAL PROVISIONS
URBAN RIGHT OF WAY RESTORATION

DESCRIPTION:

The work under this item shall consist of restoring Rights-of-Way. Contractor shall be responsible for the removal and replacement of mailboxes, drains, traffic signs, and curb street address number, sprinkler system or any other improvement within the right of way that is not paid for in other items of work.

CONSTRUCTION REQUIREMENTS:

All existing improvements as called for in this special provision to be replaced or reconstructed shall be restored to substantially the same condition as existed prior to the construction. Contractor shall document by photographing all obstructions and improvements prior to the start of construction.

As the work progresses, all streets shall be thoroughly cleaned of all rubbish, excess earth, rock, and other debris resulting from such work. All clean-up operations at the location of such work shall be accomplished at the expense of the contractor and shall be completed to the satisfaction of the engineer.

IRRIGATION SYSTEMS

DESCRIPTION:

The work shall consist of repairing any irrigation systems inside or outside the street Right of Ways as a result of damages or adjustments needed during the course of the construction to the satisfaction of the engineer.

CONSTRUCTION REQUIREMENT:

Contractor shall repair irrigation systems using like materials and shall include all materials necessary for the proper installation and function of the system. Materials such as valves, controllers, pop up spray and rotary heads, risers, seals, backflow preventer and main line pipe damaged during the course of the construction shall be re installed to its original condition. Excavation, placement, testing, back filling and compacting shall be done as required by the city of Tulsa standard specifications.

STREET ADDRESS AT CURB

DESCRIPTION:

The street address of the building, structure or lot served by the reconstructed driveway shall be painted on the curb of the driveway. Location to be approved by the Engineer. The street address shall face traffic flow.

CONSTRUCTION REQUIREMENTS:

The Street Address to be painted shall conform to city specifications as to size and form, and the quality of paint to be used, as determined by the City of Tulsa Public Works Department.

Street Address placed on the curb shall be done using a vinyl numbers stencils; letters shall be in black paint in figures of the size of three inches in height, and impressed upon a white background of the size of five by eleven inches. Standard stencil lettering with height, color and style shall be as approved by the engineer or in accordance with the most current City of Tulsa Standards.

MAILBOX REMOVAL AND RELOCATION

DESCRIPTION:

Contractor shall remove, reset and/or reconstruct any and all mailboxes within the street right of way.

CONSTRUCTION REQUIREMENTS:

The removal, resetting and/or reconstruction of mail boxes in street right of way shall be coordinated with the local postmaster as required. Mailboxes shall be located no closer than 1' behind the face of curb to face of box.

Where Special mailboxes such as Stone, masonry brick, or non standard mail boxes exist, contractor shall replace all mailboxes in like kind. The kind and quality of materials in which mailboxes shall be reconstructed shall be to the satisfaction of the property owner and approved by the engineer.

The replaced mailbox shall be capable of withstanding wind loading and lateral load associated with the delivery of the mail.

DRAINS

DESCRIPTION:

Contractor shall reestablish drains, roof drains, and other drainage through the curb.

CONSTRUCTION REQUIREMENTS:

Removal, replacement, salvage of drains in street right of way shall be done during road construction phase.

Contractor shall replace all drains in like kind. The kind and quality of materials in which drains shall be reconstructed shall be to the satisfaction of the property owner and approved by the engineer.

All re-established drains shall include a storm water curb opening as described in City of Tulsa Standard Drawing 758.

TRAFFIC SIGNS

DESCRIPTION:

Unless otherwise directed by plans and specifications, this item shall consist of removing, storing, and resetting all existing traffic signs. Contractor shall remove, store, and reset all traffic signage as required for construction of this project.

CONSTRUCTION REQUIREMENTS:

Roadside signs shall be placed at locations shown on the plans or at existing locations and shall be installed in compliance with the latest edition of the Manual on Uniform Traffic Control Devices (MUTCD).

METHOD OF MEASUREMENT:

Irrigation Systems, Street Address at the Curb, Mailbox Removal and Relocation, Drains, and Traffic Signs will be measured by EACH for the project.

PAYMENT:

Special (C) Urban Right-Of Way Restoration (measured as provided above) will be paid for at the contract unit price by EACH. Such payment shall be full compensation for all equipment, tools, labor, and incidentals necessary to complete the work as specified.

Special (C) Urban Right-Of-Way RestorationEACH

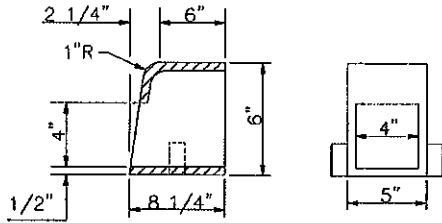

STORM WATER CURB OPENING

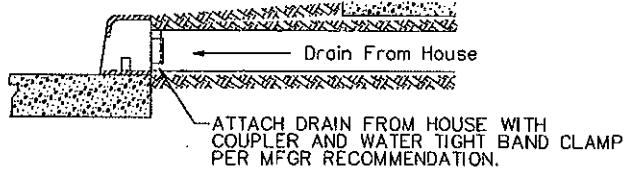

SECTION A-A

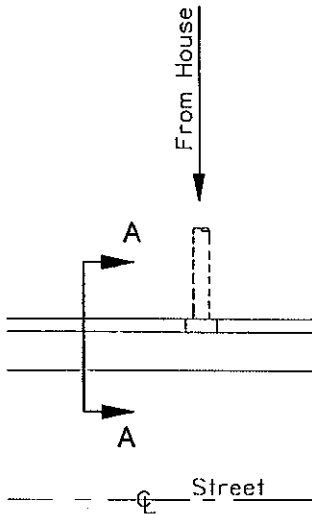

RESIDENTIAL CURB INLET

1. CONTRACTOR SHALL RECONNECT ANY SIDE DRAINS FROM ADJACENT PROPERTY THROUGH THE CURB.
2. INSTALL R-3262-3 SERIES HEAVY DUTY STORM WATER CURB OPENING BY NEENAH OR APPROVED EQUAL.
3. FIELD VERIFY SIZE AND LOCATION PRIOR TO PAVING OPERATIONS.
4. CONTRACTOR SHALL CAST INLETS IN PLACE DURING CURB PRODUCTION "CUT IN" NOT ACCEPTED.

RESIDENTIAL STORM WATER CURB OPENING	
CITY OF TULSA, OKLAHOMA PUBLIC WORKS DEPARTMENT ENGINEERING SERVICES DIVISION	
DRAWN BY: J.A.B.	APPROVED
CHECKED BY:	
DATE: OCT. 2011	
NOT TO SCALE	STANDARD NO. 758

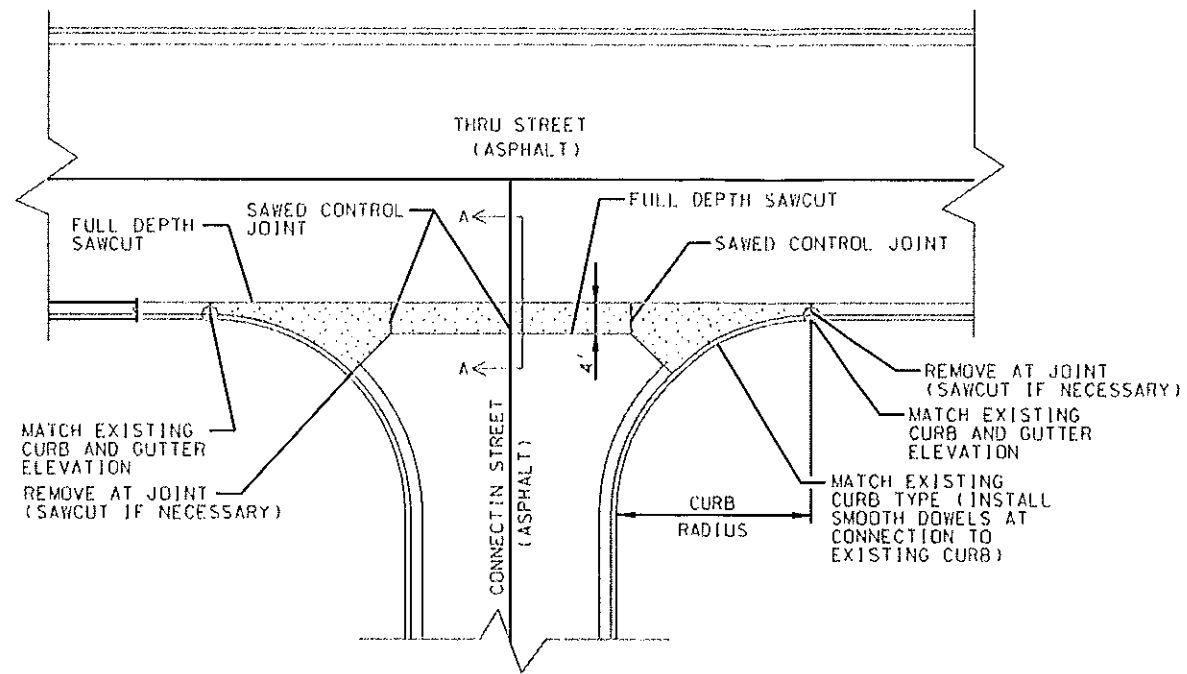

CROSS STREET CONCRETE GUTTER DETAIL

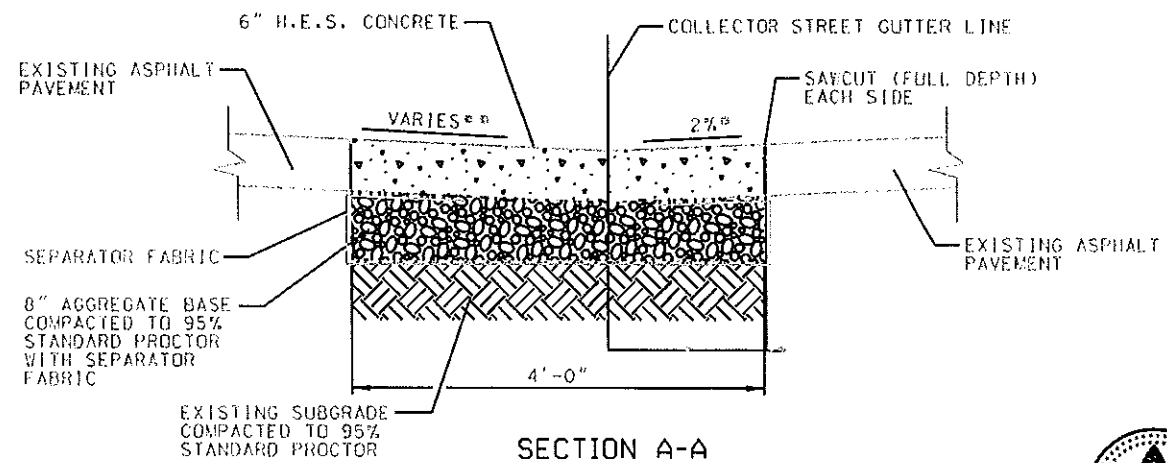

* SLOPE TO MATCH CROSS-SLOPE OF THRU STREET
 ** SLOPE TO MATCH GRADE OF CONNECTING STREET



ENGINEERING SERVICES DIVISION						
PLANS AND ESTIMATES PREPARED BY:						
DESIGNER	BY	DATE	PLAN SCALE	CREAM	OK	APPROVED
				DESIGNED	OK	
				DRAWN		
				FIELD NOTES		
				SECTION		
				DESIGNER'S SIGNATURE		
				FILED	DATE	
				SCALE		



PUBLIC WORKS
Engineering

DATE: July 01, 2025

TO: PAUL ZACHARY,
PUBLIC WORKS DEPUTY
DIRECTOR

FROM: H. SOMDECERFF, *H.S.*
PUBLIC WORKS DESIGN
MANAGER

The Specification Review Committee recommends and asks the Public Works Deputy Director to approve the following:

1. Approve Modification to Standard Detail 701 - Concrete Driveway.
2. This new Standard Detail 701 replaces the following standard details which are hereby deleted.
 - .701
 - .702
 - .703
 - .704
 - .705
 - .706
 - .707
 - .708
 - .813

Please call me at (918) 596-7355 If you have any questions.

Thank you,

APPROVED:

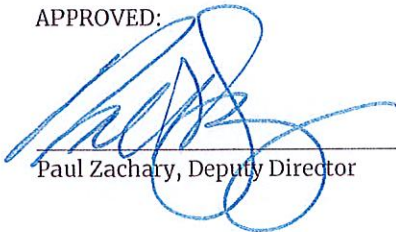
Paul Zachary, Deputy Director

07-02-25
Date

Cc: Public Works Engineering Services Specification Review Committee

PATH NAME: /E/PARTS/STD/DON_STD/701-DRIVEWAY DETAILS 1of2.DGN DJN 5/7/2025

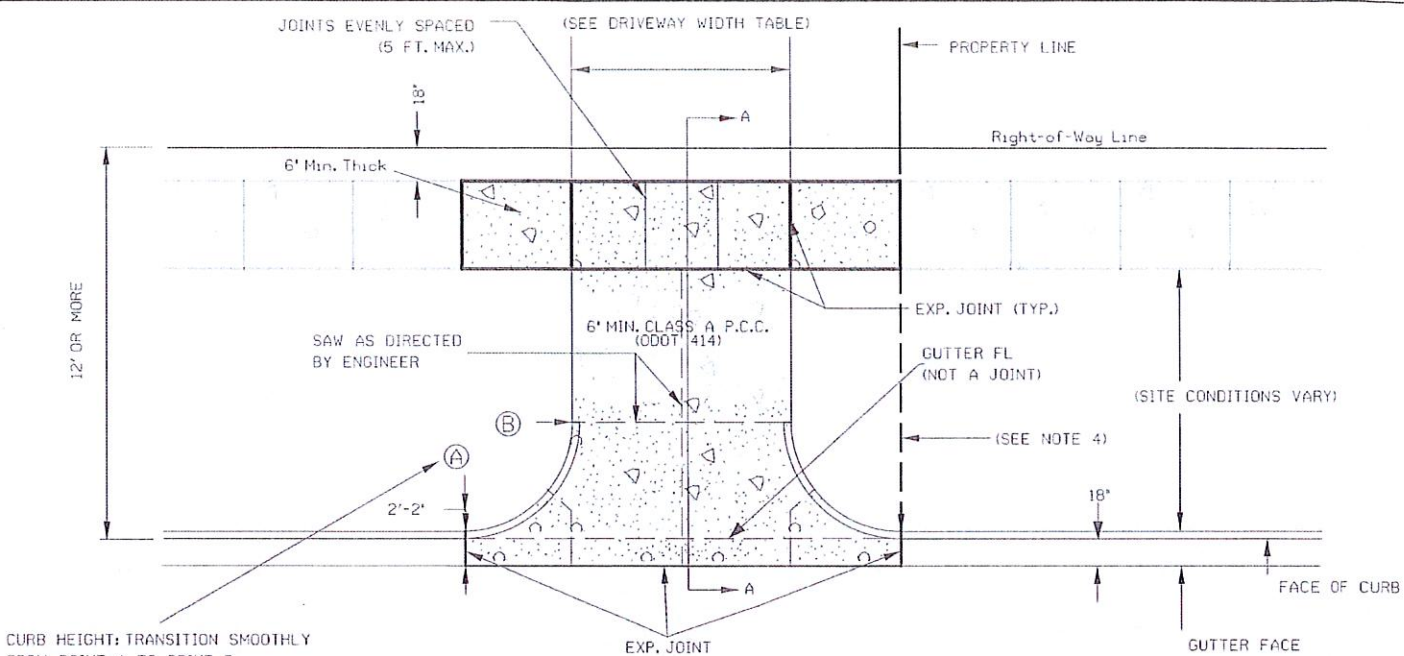

DRIVEWAY DETAIL-1A
(For Use on Curbed Concrete Streets)

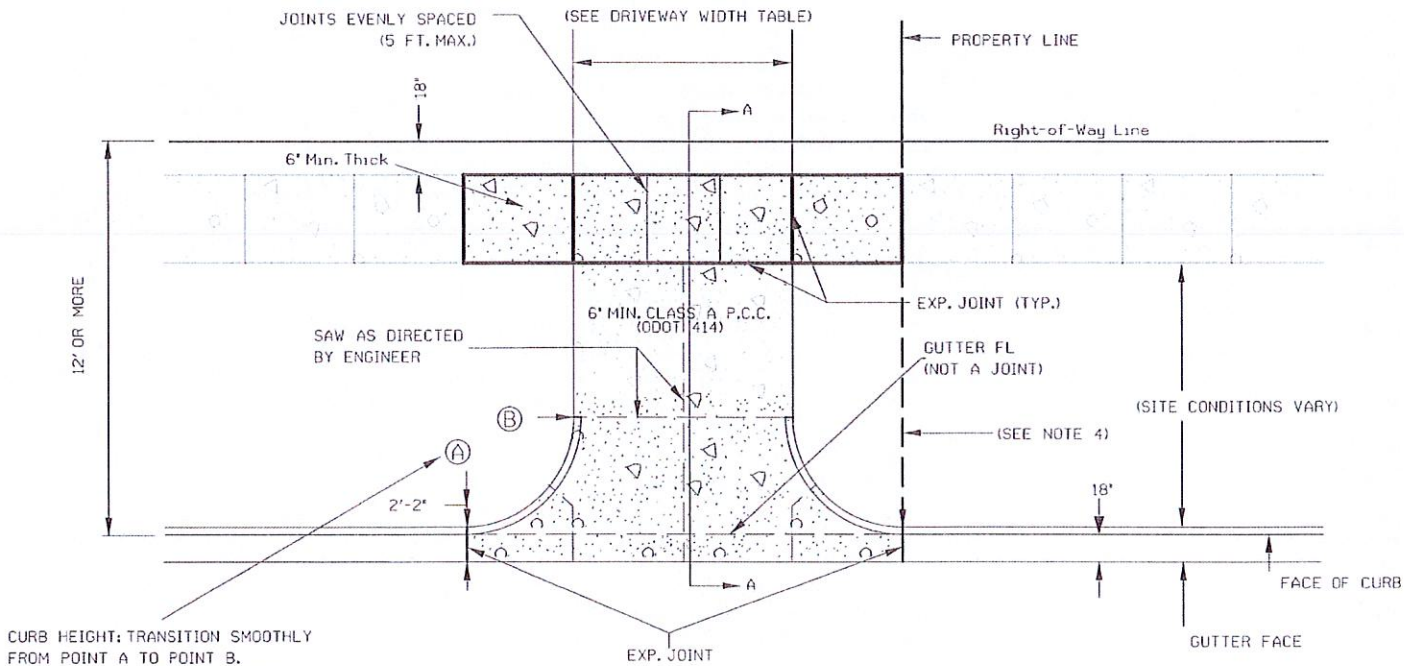

DRIVEWAY DETAIL-1B
(For Use on Curbed Asphalt Streets)

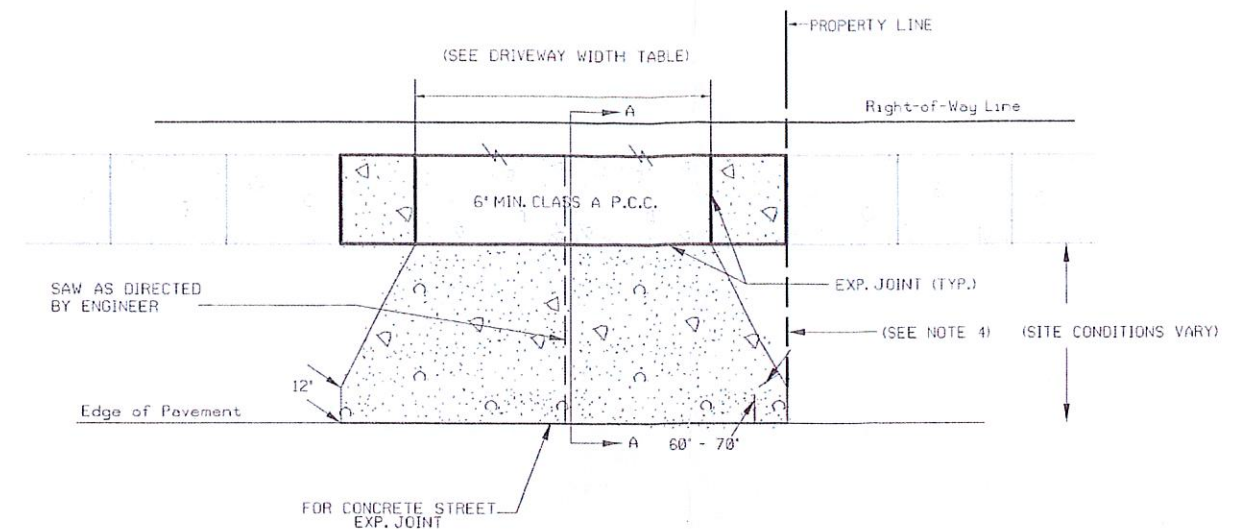
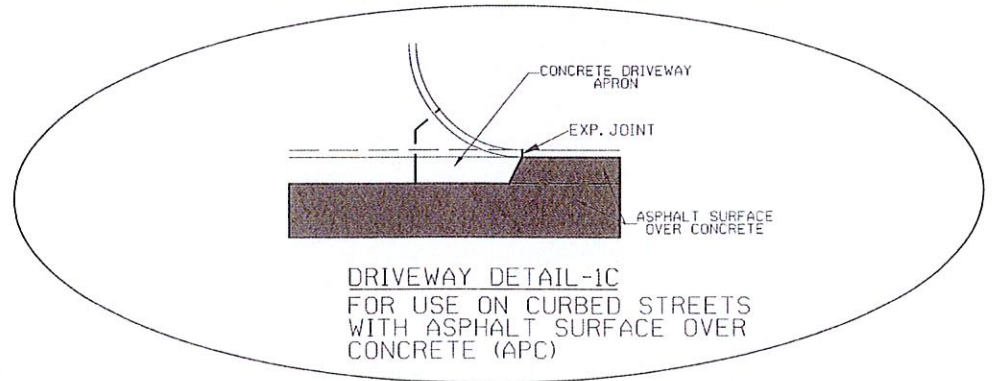

DRIVEWAY DETAIL-2
(For Use on Un-Curbed / Ditched Streets)

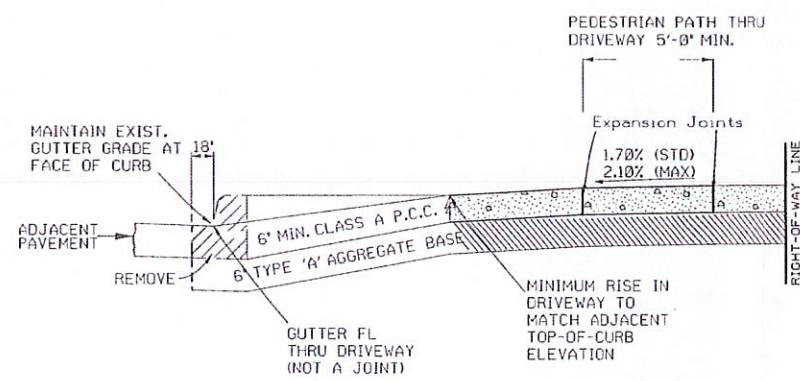

DRIVEWAY SECTION
Section A-A
(At Centerline)

GENERAL NOTES

1. NEW DRIVEWAYS SHALL BE CONSTRUCTED USING CLASS A CONCRETE. NO OTHER MATERIAL SHALL BE PERMITTED WITHOUT WRITTEN APPROVAL FROM DEVELOPMENT SERVICES.
2. DRIVEWAY DIMENSIONS SHALL BE IN ACCORDANCE WITH CITY OF TULSA ZONING CODE (SEE TABLE, THIS SHEET). VARIANCES MUST BE REQUESTED THRU DEVELOPMENT SERVICES AND APPROVED, PRIOR TO INSTALLATION.
3. COMPACTION OF TYPE A AGGREGATE BASE SHALL BE ACCORDING TO ODOT STANDARD SPECIFICATIONS - SECTION 303, LATEST EDITION (98% MODIFIED PROCTOR DENSITY, PER AASHTO T-192).
4. DRIVEWAY RADIUS SHALL NOT EXTEND BEYOND THE PROPERTY LINE EXTENSION ONTO ANOTHER ADDRESS' STREET FRONTAGE.
5. COMPACTION OF SUBGRADE TO NON-YIELDING CONDITION INCLUDED IN COST OF AGGREGATE BASE SECTION.
6. MIN. DRIVEWAY WIDTH WITHIN CITY RIGHT-OF-WAY IS 10'-0" PLUS 5' RADIUS. ANY WIDTH TRANSITION TO A NARROWER WIDTH SHALL BE CONSTRUCTED ON PRIVATE PROPERTY.
7. NO PUBLIC UTILITY METER OR VALVE SHALL BE LOCATED WITHIN A DRIVEWAY.
8. MAXIMUM SLOPE OF NEW DRIVEWAY SHALL NOT EXCEED 10.0% WITHOUT WRITTEN APPROVAL OF VARIANCE FROM DEVELOPMENT SERVICES.
9. EXPANSION JOINTS SHALL BE CONSTRUCTED PER CITY OF TULSA STANDARD 729, DETAIL A. EXPANSION JOINT FILLER MATERIAL SHALL BE NON-BITUMINOUS AND NON-ORGANIC, APPROVED BY ODOT FOR THIS USE. EXPANSION JOINTS SHALL BE SEALED USING A SELF LEVELING SILICONE PRODUCT APPROVED BY ODOT FOR THIS USE.
10. PEDESTRIAN PATH THRU DRIVEWAY MUST BE COMPLIANT WITH THE AMERICANS WITH DISABILITIES ACT.
11. WHEN ADDRESS NUMBERS ARE PAINTED ON DRIVEWAY CURB, ADDRESS NUMBER TO BE FACING DIRECTION OF ADJACENT VEHICULAR TRAFFIC.
12. PEDESTRIAN PATH THRU DRIVEWAY SHALL BE 6 INCHES MINIMUM THICKNESS OF CLASS 'A' CONCRETE.
13. FOR ASPHALT STREETS, TACK TO BE APPLIED AT INTERFACE BETWEEN DRIVEWAY AND STREET. FOR CONCRETE STREETS, EXPANSION JOINTS TO BE CONSTRUCTED AT INTERFACE.
14. FOR NEW DRIVEWAYS REQUIRING CURB REMOVAL, REMOVAL OF CURB TO BE PERFORMED WITH FULL-DEPTH SAW CUTS.
15. VARIANCES FROM STANDARD SHALL BE CONSIDERED BY THE CITY ENGINEER.
16. ALL PEDESTRIAN INFRASTRUCTURE (SIDEWALKS, RAMPS, AND APPURTENANCES) SHALL BE CONSTRUCTED WITHIN CITY RIGHT-OF-WAY, OR EASEMENT OF APPROPRIATE TYPE, AT A MINIMUM OFF SET OF 18' FROM CITY RIGHT-OF-WAY OR EASEMENT BOUNDARY.

DRIVEWAY DIMENSIONS	WIDTH (FT)		MINIMUM RADIUS (FT)
	MINIMUM	MAXIMUM	
RESIDENTIAL *	12	27	5
COMMERCIAL	24	36	15

* MAXIMUM RESIDENTIAL DRIVEWAY WIDTH IS DEPENDENT UPON LOT FRONTAGE-SEE CITY OF TULSA ZONING CODE TABLE 55-6.

REVISION	BY	DATE

Terry J. Bell
CITY ENGINEER

HAS
DESIGN MANAGER

CITY OF TULSA

CONCRETE DRIVEWAY
DETAILS 1 OF 2

DATE: MAY 2025 STD. 701 - PG 1 OF 2

PATH NAME: /E1/PARTS/STD/DCN-STD/701-DRIVEWAY DETAILS 2 OF 2.DGN D.J.N 5/22/2025

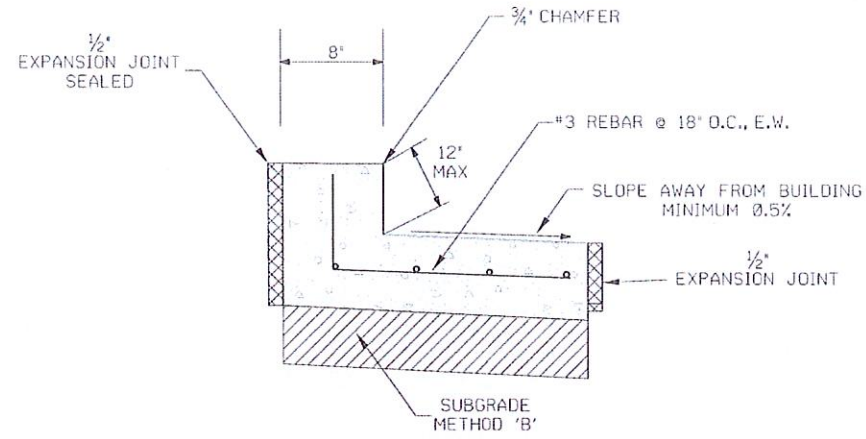

INTEGRAL SIDEWALK CURB

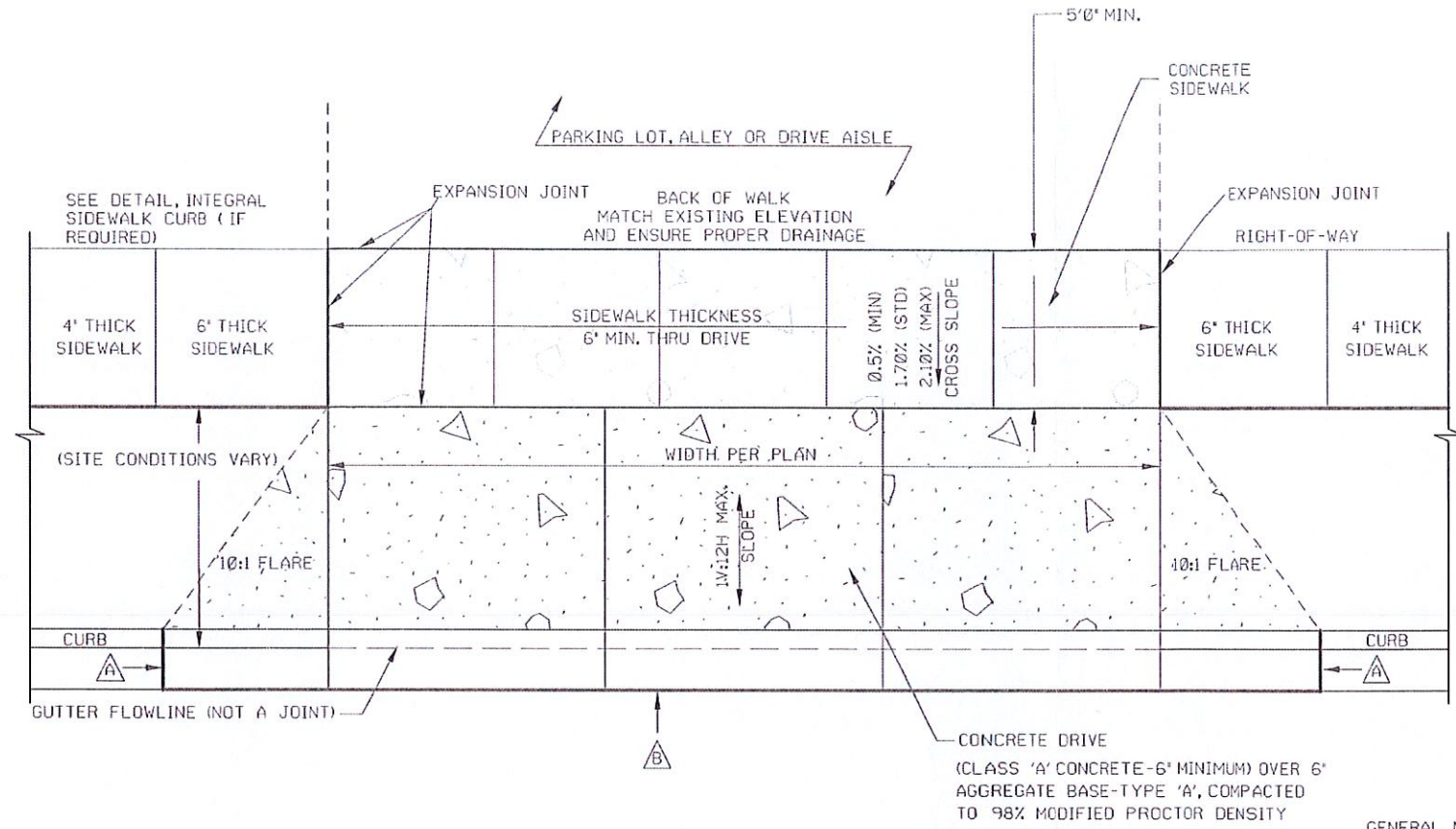

DRIVEWAY DETAIL 3

(FOR USE IN LOW/ZERO-SETBACK CONDITION, SUCH AS CENTRAL BUSINESS DISTRICT, IN CASES WHERE DETAILS 1 & 2 ARE NOT COMPATIBLE WITH SITE)

- EXPANSION JOINT-SEALED
- EXPANSION JOINT-SEALED (OMIT WHEN ADJACENT TO ASPHALT DRIVING LANE)

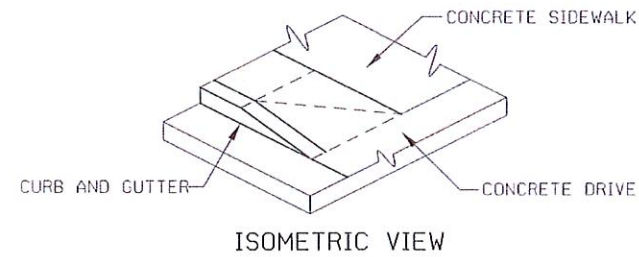

ISOMETRIC VIEW

GENERAL NOTES

- 1A. FOR INTERFACE WITH CONCRETE DRIVING LANE, EXPANSION JOINT TO BE CONSTRUCTED.
- 1B. FOR INTERFACE WITH ASPHALT DRIVING LANE, APPLY TACK COAT TO ASPHALT.
2. SIDEWALK JOINTS TO BE EVENLY SPACED THRU DRIVEWAY.
3. FIRST PANEL OUTSIDE OF SIDEWALK TO BE 6" THICK AND 5' MINIMUM WIDTH CONCRETE (BOTH SIDES OF DRIVEWAY)

REVISION	BY	DATE

Terrell
CITY ENGINEER

HAS
DESIGN MANAGER

CITY OF TULSA

CONCRETE DRIVEWAY
DETAILS 2 OF 2

DATE: MAY 2025 STD. 701 - PG 2 OF 2

PAY ITEM NOTES

1. ALL COSTS FOR REMOVING TREES, SHRUBS, STUMPS, POSTS, AND ALL OTHER DEBRIS AND/OR OBSTRUCTIONS NOT COVERED BY A SEPARATE PAY ITEM ARE INCLUDED IN THE PRICE BID.

2. THIS QUANTITY INCLUDES AN ADDITIONAL 10% ABOVE PLAN QUANTITY FOR UNDERCUTTING OF UNSUITABLE SUBGRADE MATERIAL OR ADDITIONAL PATCHING AS DIRECTED BY THE CITY OF TULSA.

3. TYPE "A" AGGREGATE BASE WAS ESTIMATED TO BE USED AS THE BASE MATERIAL FOR 90% OF THE PATCHING. QUICK SET FLOWABLE FILL WAS ESTIMATED TO BE USED AS THE BASE MATERIAL FOR 10% OF THE PATCHING. ACTUAL QUANTITIES TO BE DETERMINED BY THE CITY OF TULSA.

4. INCLUDES COMPACTION OF AGGREGATE TO 98% AASHTO T180 MODIFIED PROCTOR.

5. SEPARATOR FABRIC SHALL BE USED AT ALL PAVEMENT PATCHES AND RECONSTRUCTION SECTIONS. THE SEPARATOR FABRIC SHALL BE CUT AND OVERLAPPED A MINIMUM OF 2 FT AT ALL EDGES OF THE REPAIR.

6. THIS ITEM INCLUDES ALL COSTS ASSOCIATED WITH COLD MILLING AT A 2" DEPTH AND TO PROVIDE BUTT JOINTS AS REQUIRED. NO ADDITIONAL PAYMENT SHALL BE MADE FOR COLD MILLING BEYOND THE AVERAGE DEPTH SHOWN ON THE TYPICAL SECTIONS OR AS PREVIOUSLY STATED. WHEN CONCRETE WORK (DRIVEWAYS, CURB OR CURB & GUTTER AND SIDEWALK) IS REQUIRED ON A PARTICULAR STREET, IT SHALL BE COMPLETED PRIOR TO MILLING OPERATIONS.

7. CONSTRUCTION STAKING SHALL INCLUDE SURVEYING AND THE FURNISHING, PLACING, AND MAINTAINING OF THE CONSTRUCTION LAYOUT STAKES NECESSARY FOR THE PROPER COMPLETION AND INSPECTION OF THE ENTIRE PROJECT.

8. FABRIC REINFORCEMENT SHALL BE TENSAR GP25 OR EQUIVLENT. IF ANOTHER PRODUCT IS USED IN LIEU OF TENSAR GP25, IT MUST BE APPROVED BY THE CONSTRUCTION INSPECTOR MANAGER PRIOR TO THE START OF CONSTRUCTION. FABRIC REINFORCEMENT SHALL BE USED ON OVERLAY AREAS. THE COST OF BITUMINOUS BINDER FOR FABRIC REINFORCEMENT SHALL BE INCLUDED IN THE UNIT COST OF THIS PAY ITEM. THE BITUMINOUS BINDER SHALL MEET ODOT STANDARD SPECIFICATIONS AND THE RECOMMENDATIONS OF THE FABRIC REINFORCEMENT MANUFACTURER.

9. THIS PAY ITEM INCLUDES THE FOLLOWING:

- A. SAW CUTTING
- B. REMOVAL OF THE EXISTING CONCRETE AND/OR ASPHALTIC CONCRETE ROADWAY (CY)
- C. TYPE S3 ASPHALTIC CONCRETE OR PC CONCRETE COMPLETE AND IN PLACE PER DETAIL
- D. SEALING OF EDGES AND TACK COAT

DOES NOT INCLUDE THE FOLLOWING:

- A. UNCLASSIFIED EXCAVATION
- B. SUBGRADE METHOD B (SY)
- C. SEPARATOR FABRIC (SY)
- D. AGGREGATE BASE (TYPE A)
- E. ASPHALT CONCRETE LEVELING OR SURFACE COURSE

10. WASTE MATERIAL TO BECOME THE PROPERTY OF THE CONTRACTOR AND SHALL BE REMOVED FROM THE SITE IN A MANNER APPROVED BY THE CITY OF TULSA.

11. CONTRACTOR SHALL REPAIR ANY IRRIGATION SYSTEMS DAMAGED OR REQUIRING RELOCATION DURING THE CONSTRUCTION OF THIS PROJECT TO THE SATISFACTION OF THE PROPERTY OWNER AND CITY ARBORIST. COST SHALL BE INCLUDED IN THE PRICE BID.

12. HAY OR STRAW BALES ARE NOT ALLOWED UNDER THE OPDES GENERAL PERMIT. TEMPORARY SEDIMENT CONTROL MEASURES SHALL BE PLACED AROUND DRAINAGE INLETS AS REQUIRED UNDER ODOT SECTION 221 TEMPORARY SEDIMENT CONTROL TO PREVENT ENTRANCE OF EROSION MATERIAL. TEMPORARY SEDIMENT CONTROL MEASURES SHALL BE PLACED AND MAINTAINED AS NECESSARY TO PREVENT EROSION RUNOFF TO ADJACENT PROPERTY. ALL TEMPORARY SEDIMENT CONTROL MEASURES SHALL BE REMOVED AT THE END OF THE PROJECT AS DIRECTED BY THE CITY OF TULSA, COST TO BE INCLUDED IN THE PRICE BID.

13. THE PAY ITEM FOR SOLID SLAB SODDING INCLUDES QUANTITIES FOR PLACEMENT AND COMPACTION OF SUITABLE BACKFILL AND SOD AT EXISTING GRASS AREAS WHICH MAY BE DAMAGED DURING CONSTRUCTION OF CURBS, SIDEWALKS, DRIVEWAYS, AND OTHER MISCELLANEOUS ITEMS. THE QUANTITIES ARE BASED ON UTILIZING A 3 FOOT WIDE STRIP IN THESE AREAS. THE SOD SHALL BE OF LIKE KIND TO THE EXISTING SOD. THE CONTRACTOR WILL BE RESPONSIBLE FOR THE REPAIR OR REPLACEMENT OF DAMAGE TO EXISTING GRASS THAT EXCEEDS THESE LIMITS.

14. PAY ITEM INCLUDES ALL MOWING WITHIN THE RIGHT-OF-WAY AS DIRECTED DURING CONSTRUCTION.
15. COST OF WATERING AND FERTILIZING SHALL BE INCLUDED. FERTILIZERS SHALL BE 10-20-10 AND SHALL BE APPLIED AT THE RATE OF 1.5 LBS PER 10 SQ YDS. FERTILIZER SHALL BE APPLIED PER SECTION 230.04H OF ODOT STANDARD SPECIFICATIONS. WATERING SHALL BE APPLIED AS NECESSARY UNTIL VEGETATION IS ESTABLISHED OR UNTIL THE WORK IS ACCEPTED AS COMPLETE.
16. THE COST OF PRIME COAT, TACK COAT, EDGE JOINT SEAL MATERIAL AND SCREENINGS FOR BLOTTING, AND ALL LABOR ASSOCIATED WITH THESE ITEMS, SHALL BE INCLUDED IN ASPHALT CONCRETE.
17. ESTIMATED AT 112 LBS PER SQ YD PER 1 INCH THICK.
18. ODOT PAY FACTOR FOR AVERAGE LOT DENSITY SHALL NOT BE USED FOR THIS PROJECT. FAILURE TO REACH AVERAGE LOT DENSITY OF 92%-97% WILL RESULT IN REJECTION OF WORK.
19. LOCATIONS TO BE DETERMINED IN THE FIELD AND WORK TO BE PERFORMED AT THE DIRECTION OF THE CITY INSPECTOR. QUANTITY IS ESTIMATED AND MAY BE OMITTED IN ITS ENTIRETY.
20. THE USE OF FLY-ASH IN CONCRETE IS PROHIBITED.
21. ALL SAW CUTTING AND REMOVAL SHALL BE INCLUDED IN THE COST OF THE ITEM TO BE ADJUSTED, REMOVED, REPAIRED, OR REPLACED.
22. THIS ITEM SHALL BE MEASURED AS THE ACTUAL AMOUNT OF CURB AND/OR GUTTER INSTALLED. NO PAYMENT WILL BE MADE FOR CURB AND/OR GUTTER THROUGH DRIVEWAYS AND INLETS.
23. INCLUDES ALL COST OF SAWED JOINTS AND SEALING CONTROL JOINTS AND EXPANSION JOINTS.
24. CURB, GUTTER, AND/OR SIDEWALK ASSOCIATED WITH THE DRIVEWAY AND THROUGH THE DRIVEWAY IS INCLUDED IN THE COST OF THE DRIVEWAY.
25. ONE SIDEWALK PANEL ON EACH SIDE OF DRIVEWAYS SHALL BE A MINIMUM OF 6" THICK OR MATCH EXISTING DRIVEWAY THICKNESS, WHICHEVER IS GREATER. NO ADDITIONAL PAYMENT SHALL BE MADE FOR THE COST OF THE THICKENED SIDEWALK THROUGH THIS AREA.

26. THIS ITEM SHALL INCLUDE THE COST OF NEW MANHOLE FRAME AND COVER PER CITY OF TULSA STD NO. 753 FOR 4 FOOT I.D. MANHOLE AND STD NO. 754 FOR DGDI W/ ACCESS MANHOLE.

27. CONTRACTOR SHALL SALVAGE ALL CAST IRON INLET GRATES, INLET FRAMES, MANHOLE COVERS, MANHOLE FRAMES, AND OTHER CASTINGS. SALVAGED CASTINGS SHALL BE DELIVERED TO THE METAL RECYCLE BINS IN THE STOCKROOM AREA AT THE UNDERGROUND COLLECTIONS BASE LOCATED AT 9319 E 42ND ST N BETWEEN THE HOURS OF 7:30 AM AND 3:00 PM MONDAY THROUGH FRIDAY. ALL COST TO SALVAGE AND DELIVER CASTINGS SHALL BE INCLUDED IN THE PRICE FOR THIS ITEM. NO ADDITIONAL PAYMENT WILL BE MADE. CONTRACTOR MUST OBTAIN A RECEIPT/TRIP TICKET WITH QUANTITY DELIVERED.

28. THE TOTAL COST FOR RUBBERIZED ASPHALT AND/OR SILICONE AT MANHOLES, VALVE BOXES, INLETS, AND INLET APRONS, SHALL BE INCLUDED.

29. HOUSE NUMBERS SHALL BE REPLACED WHEN NECESSARY DUE TO CURB REPAIR AND DRIVEWAY RECONSTRUCTION. COST TO BE INCLUDED IN URBAN RIGHT OF WAY RESTORATION.

30. REINFORCED CONCRETE PIPE TO BE CLASS III. ALL REINFORCED CONCRETE PIPE AND MANHOLES TO BE SUPPLIED WITH AN OMNI-FLEX JOINT GASKET OR APPROVED EQUAL. MASTIC JOINT SEALANT SHALL NOT BE ALLOWED.

31. INCLUDES THE COST TYPE "A" FRAMES AND GRATES, CAST IRON CURB INLETS, RCP REQUIRED TO MAKE CONNECTION AND REMOVAL OF EXISTING INLETS. THE COST OF PC CONCRETE CURB AND GUTTER THROUGH THE INLET, 5' EACH SIDE OF THE INLET, AND THE PC CONCRETE INLET APRON SHALL BE INCLUDED. GRATE AND FLOWLINE ELEVATIONS SHALL MATCH EXISTING CONDITIONS UNLESS OTHERWISE NOTED IN THE PLANS.

32. QUICK SET FLOWABLE FILL TO BE USED TO BACKFILL AROUND ALL STREET CURB INLETS AND PIPE.

33. ALL INLETS TO BE CAST IN PLACE CONCRETE OR PRECAST CONCRETE. NO BRICK INLETS SHALL BE ALLOWED. INLETS TO BE COMPLETE IN PLACE. ALL PIPE REPLACEMENT DUE TO REMOVAL OF INLET SHALL BE APPROVED BY CITY OF TULSA. PIPE TO BE SIZE OF EXISTING PIPE OR LARGER AS SPECIFIED.

34. NO MASONRY STRUCTURES SHALL BE CONSTRUCTED WITHIN THE RIGHT OF WAY.

35. ADDITIONAL DEPTH IN INLET SHALL BE MEASURED AND PAID FOR ALL INLETS EXCEEDING 3.71 VERTICAL FT, CALCULATED FROM THE CENTER ELEVATION OF THE LOWEST CAST IRON CURB TO THE FLOWLINE OF THE OUTLET PIPE.

36. ALL PLASTIC PAVEMENT MARKINGS SHALL BE EXTRUDED-APPLIED THERMOPLASTIC. MECHANICALLY APPLIED PREFORMED PLASTIC TAPE ("COLD TAPE") WILL NOT BE ACCEPTED. THERMOPLASTIC PAVEMENT MARKINGS SHALL ONLY BE APPLIED WHEN THE AMBIENT TEMPERATURE EXCEEDS 55°F FOR ALL OF THE SIX HOURS PRIOR TO INSTALLATION AND MAXIMUM WIND GUSTS ARE BELOW 15 MPH AT THE TIME OF APPLICATION. PRICE BID TO INCLUDE FLEX TABS OR LIKE FOR POST CONSTRUCTION LANE MARKING/SEPARATION. CONTRACTOR SHALL SUBMIT TO THE CITY OF TULSA A STRIPING SCHEDULE WITH THEIR PAVING OPERATIONS PLAN. COST OF STRIPING TO INCLUDE THE REMOVAL OF EXISTING STRIPING PRIOR TO APPLICATION OF NEW STRIPING WITHIN THE LIMITS OF CONTRACT WHERE APPLICABLE. (I.E. – CONCRETE AREAS INSIDE THE LIMITS OF AN MPO).

37. REFLECTORIZED SHEETING ON SIGNS AND BARRICADES SHALL BE OF A CUBIC PRISMATIC TYPE AND SHALL MEET THE SPECIFICATIONS ESTABLISHED FOR ASTM D 4956-01 TYPE IX RETROREFLECTIVE SHEETING. REFLECTORIZED SHEETING ON DRUMS AND TUBE CHANNELIZERS SHALL BE OF A HIGH-INTENSITY TYPE AND SHALL MEET THE SPECIFICATIONS ESTABLISHED FOR ASTM D 4956-01 TYPE III RETROREFLECTIVE SHEETING.

38. IF WARNING LIGHTS ARE TO BE USED ON TRAFFIC CONTROL DEVICES, TYPE "A" LIGHTS SHALL ONLY BE USED ON DEVICES WARNING OF UNEXPECTED HAZARDS, AND SHALL NOT BE USED FOR DELINEATION OF THE TRAVELED WAY. ONLY TYPE "C" WARNING LIGHTS SHALL BE USED FOR DELINEATION OF THE TRAVELED WAY, AND TYPE "C" LIGHTS SHALL NOT BE USED FOR ANY OTHER PURPOSE.

39. THE PAY ITEM FOR FLAGGER SHALL BE PAID FOR ON A FLAG DAY (F.D.) BASIS. ONE F.D. IS ONE COMPLETE WORKDAY AS PERFORMED BY THE CONTRACTOR SET FORTH IN THE CONTRACT DOCUMENTS AND SPECIFICATIONS.

40. THE CONTRACTOR WILL BE PAID FOR UNCLASSIFIED EXCAVATION ON THE BASIS OF ACTUAL QUANTITY. ANY ADDITIONAL EXCAVATION REQUIRED OR OVERRUN OF PLAN QUANTITY WILL BE PAID FOR ON THE BASIS OF UNIT PRICE BID FOR THE ITEM.

41. A CERTIFIED ARBORIST SHALL OVERSEE ALL PLANTINGS. CONTACT CITY ARBORIST TO ACCEPT FINAL PLANTINGS. CONTACT #: 918-591-4344

42. TREE GRATES ARE NOT ACCEPTABLE PER CITY ARBORIST. CONCRETE PAVERS ARE TO BE USED AS NECESSARY AROUND TREES.

43. UNIT PRICE SHALL INCLUDE COST OF ALL MATERIAL, LABOR, AND EQUIPMENT REQUIRED TO CONSTRUCT WALL PER MANUFACTURER'S RECOMMENDATIONS.

44. ADDITIONAL DEPTH IN A MANHOLE SHALL BE MEASURED FROM 6FT AS MEASURED FROM THE TOP OF RIM TO THE LOWEST FLOWLINE.

45. ASPHALT QUANTITIES ARE ESTIMATED ON A 2" REPLACEMENT, ANY ADDITIONAL THICKNESS OF ASPHALT OVER 2" WILL NOT BE PAID FOR WITHOUT PRIOR WRITTEN APPROVAL FROM THE CITY OF TULSA.

46. PRICE BID FOR THIS ITEM SHALL BE PAYMENT IN FULL FOR THE INSTALLATION, MAINTENANCE AND SUBSEQUENT REMOVAL OF ALL NECESSARY CONSTRUCTION TRAFFIC CONTROL REQUIRED FOR COMPLETION OF THE PROJECT.

47. THE COST TO REPLACE REMOVED OR DAMAGED SECTION CORNERS AND ALL OTHER PERMANENT RIGHT OF WAY MARKERS SHALL BE INCLUDED IN THE PRICE BID FOR THIS ITEM. NO ADDITIONAL PAYMENT WILL BE MADE.

48. ALL EXISTING DRAINAGE STRUCTURES SHALL BE CLEANED AND CLEARED OF ALL SEDIMENTATION AND DEBRIS TO THE RIGHT OF WAY. COST OF CLEARING SHALL BE INCLUDED IN THE PRICE BID.

49. ALL TRANSVERSE AND LONGITUDINAL DOWEL BARS AND RACKS SHALL BE INCLUDED IN THE PRICE BID FOR PATCHING AND WILL NOT BE PAID FOR SEPERATELY.

50. SIDEWALK RAMPS SHOULD BE BUILT IN ACCORDANCE WITH CITY OF TULSA STANDARD DRAWINGS NUMBER 790, AS SHOWN ON THE PLANS OR AS DIRECTED BY THE CITY OF TULSA. ALL RAMPS SHALL MEET PROWAG AND ADA STANDARDS.

51. INLET APRONS SHALL BE PAID FOR AS REMOVE AND REPLACE 6" CURB AND GUTTER.

52. CONTRACTOR SHALL SUBMIT TO THE CITY OF TULSA A WRITTEN REQUEST IN THE EVENT THAT TEMPORARY STRIPING TAPE IS NECESSARY ON AN ARTERIAL STREET FOR DELINEATION AND SEPARATION OF HEAD-TO-HEAD TRAFFIC DURING THE CONSTRUCTION PERIOD. TEMPORARY TRAFFIC CONTROL STRIPING SHALL BE MAINTAINED AT ALL TIMES AND IS SUBJECT TO ALL REQUIREMENTS FOUND IN THE SPECIAL PROVISIONS-GENERAL.

SPECIAL PROVISION
MULTI-AXIAL COMPOSITE PAVING GRID

PART 1 – GENERAL

1.01 DESCRIPTION

This Section includes specifications for placing the composite paving grid at the locations and to the dimensions shown on the Plans and as directed by the Engineer. The composite paving grid shall be placed on existing asphalt or concrete pavement to be overlaid with either hot mix or warm mix asphalt concrete.

As installed, Interlayer must meet the following performance objectives:

1. Form a moisture barrier to protect against moisture intrusion from top down into base.
2. Provide multi-axial tensile reinforcement which limits elongation in all directions to maximize the delay and reduced severity of reflective cracks.
3. Must be available in up to 12.5-foot widths to reduce longitudinal laps.
4. Must result in a compatible, laminated, bonded structure between lifts of HMA.

PART 2 – PRODUCT

2.01 MATERIALS

- A. Shall be an engineered multi-axial composite paving grid interlayer constructed of uncoated, multi-directional, continuous strand, high strength fiberglass fibers, bound to a carrier that when properly saturated with hot asphalt binder forms a moisture barrier and provides multi-directional tensile conforming to the following test methods and physical properties:

Table 2.01 A – Multi-Axial Composite Paving Grid Nominal Properties

Property	ASTM Test Method	Units	Avg. Roll Value
Tensile Strength @ 0° Tensile Strength @ 90° ¹Tensile Strength @ 45° ¹Tensile Strength @ -45°	D6637 Method A modified¹	lbs./in (kN/m)	459(80)
Elongation at Max Load		%	< 3.0
Melting Point (glass)	D276	°F (°C)	752° (400°)
Asphalt Retention	D6140	gal/yd² (liters/m²)	.17 (0.8)
Mass per Unit Area	D5261	oz/yd² (g/m²)	16 (452)
Glass by Weight		%	85

¹In paving applications, bias angle tensile strength can be a factor in mitigating multi-directional crack propagation. Tested per ASTM D6637 to determine Tensile Strength values of the continuous strand fiberglass filaments.

- B. The paving grid shall conform to all design and nominal performance properties of TenCate Mirafi MPG4 paving grid, manufactured in USA as listed above. All other submittals will be rejected unless received along with independent confirmation of the material values and approved by project engineer at least 2 weeks prior to bid date.

2.02 STORAGE

- A. he paving interlayer rolls shall be protected from dust, dirt and the elements. A durable label, indicating manufacturer, product name or style number, roll and lot number, and roll dimensions shall be attached to each roll. T
- B. he paving interlayer rolls shall be delivered, stored and handled in a manner to prevent damage and shall be inspected for defects and damage prior to use. T
- C. he paving interlayer shall be stored as manufacturer recommends: in a dry covered condition, free from dust, dirt, off the ground, protected from precipitation, ultraviolet radiation, strong chemicals, sparks and flames, temperatures in excess 71 °C (160 °F) and other environmental condition that could cause damage. T

PART 3 – EXECUTION

3.01 SURFACE PREPARATION

- A. All areas of base failure shall be removed and replaced to acceptable industry standards for the specific traffic loads and condition of the project.
- B. In an overlay or milled surface application repair all failed pavement areas prior to installation of the paving interlayer. Fill all cracks ¼" or greater with approved material.
- C. Immediately prior to placement of paving interlayer, the pavement surface shall be dry, cleaned of anything that would interfere with adhesion, for E.g., vegetation, dirt, gravel or water.
- D. A leveling or "scratch" course is recommended when road surface is not acceptable and shall be of proper gradation and sufficient thickness to achieve a smooth, level surface with no gaps greater than ¼" depth and width or be acceptable to the project engineer.
- E. A finish grind may be used as an alternative to an asphalt leveling course being placed, when you can achieve the final surface texture has no cracks, gaps or vertical angles greater the ¼" depth and width or be acceptable to the project engineer. In all cases the surface must be clean and dry, and the application rate of the Hot PG grade asphalt binder shall be increased to insure complete interlayer saturation and bonding. Suggest review of Asphalt Interlayer Association input: "Other Industry Resources" below.

3.02 INSTALLATION

- A. Over a new asphalt section or where a leveling course has been installed, apply the paving interlayer grid in a hot PG graded asphalt binder. Asphalt Emulsion is NOT acceptable for placing paving interlayer due to time delay for it to break and the difficulty in insuring quality as installed.
- B. Asphalt Binder
 - 1. A hot asphalt binder shall be applied to saturate the paving interlayer (min. to be the asphalt retention rate) plus amount needed to bond to existing surface and the new overlay. The asphalt binder to be used shall be PG 58 or higher. Sustained ambient temperatures (above 90°) may require a stiffer binder gradation like PG70 or higher to improve set time and reduce risk of grid pick-up under construction traffic.
 - 2. The hot asphalt binder shall be applied at a rate of 0.18 to 0.20 gal./SY on a new HMA leveling surface. On an old smooth surface or a clean fine milled surface apply hot asphalt binder at a rate of 0.19 and 0.21 gal./SY or as recommended by the paving interlayer manufacturer or as directed by the Engineer.
 - 3. The hot asphalt binder shall be applied by a distributor truck in a smooth uniform manner at as low a temperature as is possible to achieve the right application rate, depending on ambient and road surface temperatures and type of PG asphalt binder used. Target 177 °C (350 °F) or below in most cases. Spray application shall extend four (4) inches wider than width of paving interlayer on lap side.
- C. The paving interlayer shall be installed with equipment in good working order that can install the grid without wrinkles or manually as needed and recommended by manufacturer.
 - 1. If manual lay-down methods are used, the composite paving grid shall be unrolled, aligned, and placed in increments of approximately thirty (30) feet or as project engineer suggest.
 - 2. The material shall be placed flat and wrinkle-free. The paving interlayer installation may require hand sweeping as necessary to eliminate ripples that may occur during installation.
 - 3. To ease installations around curves, the paving grid can be placed in shortened lengths by mechanical equipment or by hand.
 - 4. Paving interlayer shall be lapped two (2) to four (4) inches longitudinally and two (2) to four (4) inches transversely. Transverse laps shall be in the direction of the asphalt concrete overlay placement insuring hot asphalt binder is placed under the overlap.
 - 5. Sweeping of paving interlayer is required to insure adequate adhesion into the hot asphalt binder. If the interlayer wrinkles more than 1" height during installation, the wrinkle shall be cut and lapped in the direction of paving.

6. Paving interlayer to be installed with the glass grid facing down to existing surface.
7. Turning of construction equipment and other vehicles shall be gradual and kept to a minimum to avoid damage to the paving interlayer. If excessive heat, overspray, or turning cannot be eliminated then spreading small quantities of HMA or clean blotting sand onto the interlayer may be required in the affected area. Excess blotting sand shall be removed before installing HMAC over the interlayer.
8. After installing the paving interlayer, the pavement may be opened to traffic at the contractors/engineer's discretion. Caution: Parking on the installed paving grid prior to final overlay for extended periods could cause damage to the grid.
9. Paving interlayer should never be installed when it or the pavement surface is wet.
10. Minimum HMAC overlay thickness recommended is 2", but in no case, less than 1.5" thick and should be in accordance with the Asphalt Institute (AI) guidelines. (See "Other Industry Resources" below)

NOTE: Minimum lift thickness should be at least 3 times the nominal maximum aggregate size to ensure aggregate can align themselves during compaction to achieve required density and to ensure mix is impermeable.

3.03 WORKMANSHIP AND QUALITY CONTROL

A. PAVING INTERLAYER INSTALLATION QUALITY CONTROL

The project engineer shall confirm the proper installation of the paving interlayer by, at their discretion:

1. Daily, contractor to certify that interlayer was installed per plans and specifications and confirm, by weight tickets and measuring asphalt used, that the hot asphalt binder usage equates to the specified amount for proper interlayer saturation and bonding.
2. Hot asphalt binder application rate shall not be reduced without Project Engineer approval.
3. Certification of compliance from the binder supplier shall be provided for each load of hot asphalt binder delivered to the jobsite, showing the type and quality of material delivered.
4. Installing contractor shall be provided satisfactory confirmation to the Project Engineer showing the total quantity of asphalt binder was installed, at the proper application rate as published by the manufacturer on the entire project. Suggest weight tickets just prior to arrival to and exit from jobsite from an independent weight station.

5. QA/QC inspection is at the discretion of the Project Engineer. The Project Engineer can choose to implement any or all the following:
 - a. Self-inspecting
 - b. Requesting the interlayer Manufacturer's Technical Representative be present
 - c. Using an independent 3rd party, approved by the project engineer to inspect installation and paid for by the installing contractor as a separate line item.
6. The installing contractor shall give enough notice of planned work schedule such that proper inspection of workmanship is accomplished.
7. Contractor to schedule with inspector and no work shall be done without the QA/QC inspector on-site or as determined by the project engineer.

B. MEASUREMENT AND PAYMENT

Payment for the paving interlayer shall be measured and paid for at the contract unit bid price per square yard, and shall include full compensation for furnishing all labor, tools equipment and incidentals for doing all the work involved in placement of the paving interlayer.

Payment for the hot asphalt binder application shall be by the ton and shall include all labor, materials and equipment necessary to apply the hot asphalt binder.

OTHER CONSIDERATIONS:

At the project engineer's discretion, consider adding the following:

Under Section 1.01 DESCRIPTION:

As installed, Interlayer must meet the following performance objectives:

5. Form a moisture barrier to protect against moisture intrusion from top down into base.
6. Provide multi-axial tensile reinforcement which limits elongation in all directions to maximize the delay and reduced severity of reflective cracks.
7. Must be available in up to 12.5-foot widths to reduce longitudinal laps.
8. Must result in a compatible, laminated, bonded structure between lifts of HMA.

Under Section 2.01 MATERIALS:

To achieve #2 above, include specific testing to determine the materials Multi-Axial capability.

1. In addition to machine direction and cross machine direction, material must be tested on the bias angle per ASTM D6637 modified to confirm limited elongation in all directions to engage tensile for maximum delay and reduced severity of reflective cracks.

Under Section 3.03 WORKMANSHIP AND QUALITY CONTROL:

A. PAVING MAT INSTALLATION QUALITY CONTROL

1. QA/QC inspection is at the discretion of the project engineer.
 - a. Self-inspecting
 - b. Requesting the interlayer Manufacturer's Technical Representative be present
 - c. Using an independent 3rd party, approved by the project engineer to inspect installation and paid for by the installing contractor as a separate line item.
2. The installing contractor shall give enough notice of planned work schedule such that proper inspection of workmanship is accomplished.
3. Contractor to schedule with inspector and no work shall be done without the QA/QC inspector on-site or as determined by the project engineer.
4. Daily, contractor to certify that interlayer was installed per plans and specifications and confirm, by weight tickets and measuring asphalt used, that the hot asphalt binder usage equates to the specified amount for proper interlayer saturation and bonding.

INDUSTRY RESOURCES:

Asphalt Interlayer Association: Grinding Specification:

When Finish, Grinding is used as an alternative to an asphalt leveling course being placed over conventional grinding prior to the placement of an Interlayer product, the following specifications shall apply:

The cold milling equipment and operation shall have the capability to;

- 1) Remove asphalt concrete a minimum depth of 6mm (1/4 inch)
- 2) Provide a surface relief (distance between ridges) of no more than 6mm (1/4 inch)
- 3) Maintain a 6mm (1/4 inch) grade tolerance (transverse and longitudinally)

The equipment shall include the following features;

- A.) Minimum of 3 riding tracks
- B.) An automatic grade control system with an electronic averaging system having 3 sensors on each side of the machine
- C.) A drum that operates in the up-milling direction
- D.) Bullet tooth tools with tungsten carbide steel cutting tips
- E.) A 6mm (1/4 inch) tool spacing

The contractor shall select which sensors are activated during the milling operation to produce the profile required as shown on the plans. The cold milling equipment shall have a complete set of new tooth tools at the beginning of the job. The tooth tools shall be replaced as necessary to maintain the tolerances listed above. All removed materials shall become the property of the Contractor. Removed asphalt concrete surfacing will be measured by the square meter. The contract price paid per square meter for removal of asphalt concrete surfacing shall include full compensation for furnishing all labor, materials, tools, and incidentals and for doing all work involved in removing asphalt concrete surfacing as specified and shown on the plans. All areas that have been ground shall be swept with power equipment which will remove all grinding and debris prior to placement of the Interlayer.

Asphalt Institute: Hot Mix Asphalt Thickness:

Nominal aggregate size dictates lift thickness. Minimum lift thickness should be at least 3 times the nominal maximum aggregate size to ensure aggregate can align themselves during compaction to achieve required density and to ensure mix is impermeable. Therefore, the desired lift thickness can direct the decision on nominal aggregate size to use.

The maximum lift thickness is dependent also upon the type of compaction equipment that is being used. When static steel-wheeled rollers are used, the maximum lift thickness that can be properly compacted is 3 inches. When pneumatic or vibratory rollers are used, the maximum thickness of lift that can be compacted is almost unlimited. Generally, lift thicknesses are limited to 6 or 8 inches. Proper placement becomes a problem in lifts thicker than 6 or 8 inches.

For open-graded mixes, compaction is not an issue since it is intended that these types of mixes remain very open. Therefore, the maximum size aggregate can be as much as 80 percent of the lift thickness.

GENERAL CONSTRUCTION NOTES

GENERAL CONSTRUCTION NOTES

1. ALL CONSTRUCTION AND MATERIALS SHALL BE IN ACCORDANCE WITH THE 2019 OKLAHOMA DEPARTMENT OF TRANSPORTATION STANDARD SPECIFICATIONS FOR HIGHWAY CONSTRUCTION AND THE CURRENT CITY OF TULSA PUBLIC WORKS DEPARTMENT STANDARD SPECIFICATIONS AND STANDARD DETAILS AND STANDARD DRAWINGS AND CITY OF TULSA SPECIAL PROVISIONS.

2. THE CONTRACTOR SHALL COMPLY WITH ALL FEDERAL, STATE AND LOCAL LAWS GOVERNING SAFETY, HEALTH AND SANITATION. THE CONTRACTOR SHALL PROVIDE ALL SAFEGUARDS, SAFETY DEVICES AND PROTECTIVE EQUIPMENT, AND TAKE ANY OTHER NEEDED ACTION ON AS HIS OWN RESPONSIBILITY OR AS THE CITY OF TULSA MAY DETERMINE REASONABLY NECESSARY TO PROTECT PROPERTY IN CONNECTION WITH THE PERFORMANCE OF WORK COVERED BY THE CONTRACT.

3. PAY ITEMS SHALL BE AS SPECIFIED ON THE CITY OF TULSA OR ON THE ODOT STANDARD DRAWINGS EXCEPT AS MODIFIED BY THE CONTRACT.

4. THE CONTRACTOR SHALL DETERMINE THE EXACT LOCATION OF ALL EXISTING UTILITIES BEFORE COMMENCING WORK IN EACH AREA. THE CONTRACTOR IS FULLY RESPONSIBLE FOR ANY AND ALL DAMAGES WHICH MIGHT RESULT FROM HIS FAILURE TO LOCATE AND PRESERVE ANY AND ALL UTILITIES.

5. THE LOCATIONS OF THE UTILITIES ARE SHOWN ACCORDING TO ALL AVAILABLE INFORMATION. THE CONTRACTOR SHALL NOTIFY EACH UTILITY OWNER PRIOR TO COMMENCEMENT OF WORK TO VERIFY BOTH HORIZONTAL AND VERTICAL LOCATIONS. THE FOLLOWING IS A LIST OF UTILITY OWNERS:

SOUTHWESTERN BELL 918-495-2200

PUBLIC SERVICE COMPANY OF OKLAHOMA (AEP) 918-599-2217

OKLAHOMA NATURAL GAS (ONG) 918-588-7000 EXT.676

COX COMMUNICATIONS 918-628-3635

MCI 918-590-2160

WELLSCO VALLOR TELECOM 918-451-3441

CITY OF TULSA-WATER AND SEWER 918-596-9560

CITY OF TULSA-TRAFFIC OPERATIONS 918-596-9766

6. THE CONTRACTOR SHALL GIVE THE NOTIFICATION CENTER OF OKLAHOMA ONE-CALL SYSTEM, INC. NOTICE OF ANY EXCAVATION NO SOONER THAN TEN DAYS NOR LATER THAN 48 HOURS, EXCLUDING SATURDAYS, SUNDAYS AND LEGAL HOLIDAYS, PRIOR TO THE COMMENCEMENT OF WORK. PHONE 1-800-522-6543.

GENERAL CONSTRUCTION NOTES

7. THE CONTRACTOR SHALL TAKE REASONABLE PRECAUTIONS TO PREVENT EXCESS MOISTURE FROM INCLEMENT WEATHER OR OTHER SOURCES FROM ENTERING ANY STREET EXCAVATION. IF EXCESS MOISTURE DOES ENTER THE EXCAVATION THROUGH THE NEGLIGENCE OF THE CONTRACTOR AND THE ADJOINING PAVEMENT IS ADVERSELY AFFECTED BY THE EXCESS MOISTURE, THE CONTRACTOR SHALL REPLACE THE ADJOINING PAVEMENT AND SUBBASE AT HIS SOLE EXPENSE.

8. THE CONTRACTOR SHALL PRESERVE THE INTEGRITY OF THE SANITARY SEWER STRUCTURES AND ALL OTHER UTILITY STRUCTURES WITHIN THE PROJECT EXTENTS.

9. THE CONTRACTOR SHALL WORK IN COOPERATION WITH THE CITY OF TULSA TO ESTABLISH, INSTALL, MAINTAIN, AND OPERATE COMPLETE, ADEQUATE, AND SAFE TRAFFIC CONTROLS DURING THE ENTIRE CONSTRUCTION PERIOD. ALL FLAGMEN, BARRICADES, AND TRAFFIC CONTROL DEVICES SHALL BE APPROVED BY THE STREET MAINTENANCE AND INSPECTION REPRESENTATIVE.

10. CONSTRUCTION SIGNAGE WILL BE INSTALLED IN A MANNER APPROVED BY THE CITY OF TULSA, IN ACCORDANCE WITH CHAPTER VI OF THE MANUAL ON UNIFORM TRAFFIC CONTROL DEVICES, CURRENT ADDITION, AND APPLICABLE ODOT STANDARD DRAWINGS. THE CONTRACTOR SHALL PROVIDE A PROPOSED TRAFFIC CONTROL PLAN FOR APPROVAL BY THE CITY OF TULSA PRIOR TO BEGINNING WORK. TRAFFIC CONTROL DEVICES SHALL NOT BE PLACED ON SIDEWALKS. IN AN EVENT THAT SIDEWALK NEEDS TO BE BLOCKED FOR CONSTRUCTION PURPOSES "ONLY", CONTRACTOR SHALL PROVIDE A PEDESTRIAN DETOUR. AT NO TIME SHALL A BIKE LANE BE BLOCKED.

11. THE CONTRACTOR SHALL NOTIFY THE CITY OF TULSA STREET MAINTENANCE AND INSPECTION AT 918-576-5514, A MINIMUM OF 48 HOURS PRIOR TO COMMENCING WORK OR PRIOR TO REMOVING TRAFFIC SIGNS. ALL SIGNS SHALL BE HANDLED IN A MANNER SO AS NOT TO DAMAGE THE SIGN AND/OR POST. ALL TRAFFIC SIGNS THAT ARE DAMAGED AND/OR REMOVED DUE TO CONSTRUCTION SHALL BE REPLACED WITH A NEW AND UNDAMAGED TRAFFIC SIGNS.

12. THE CONTRACTOR SHALL BE RESPONSIBLE FOR REMOVING AND PROPERLY DISPOSING OF ALL PERMANENT ROAD SIGNS AFFECTED BY THE CONSTRUCTION OPERATIONS. IN ADDITION, THE CONTRACTOR SHALL DELIVER THEM TO TRAFFIC OPERATIONS AT 4015 N. HARVARD AVENUE, TULSA, OK 74115. PRIVATE SIGNS LOCATED WITHIN THE LIMITS OF THE RIGHT-OF-WAY SHALL BE REMOVED BY THEIR RESPECTIVE OWNERS.

GENERAL CONSTRUCTION NOTES

13. THE CONTRACTOR WILL BE RESPONSIBLE FOR PREPARATION AND DISTRIBUTION OF A WRITTEN NOTICE TO RESIDENTS 48 HOURS PRIOR TO BEGINNING PAVEMENT REMOVAL AND MILLING AND OVERLAY OPERATIONS. CONTRACTOR SHALL PROVIDE WRITTEN NOTICE TO THE CITY OF TULSA THAT NOTICE HAS BEEN PROPERLY GIVEN.

14. LOCAL AND THROUGH TRAFFIC SHALL BE MAINTAINED THROUGH THE PROJECT AT ALL TIMES.

15. ALL PUBLIC AND PRIVATE STREETS AND DRIVES SHALL BE ACCESSIBLE AT ALL TIMES.

16. ALL BROKEN CONCRETE, WASTE MATERIAL, AND OTHER DEBRIS SHALL BECOME THE PROPERTY OF THE CONTRACTOR AND SHALL BE REMOVED FROM THE LIMITS OF THE PROJECT AND DISPOSED OF IN A MANNER APPROVED BY THE CITY OF TULSA. NO ADDITIONAL PAYMENT WILL BE MADE FOR THE DISPOSAL OF THIS MATERIAL.

17. ALL EXCAVATED MATERIAL NOT REQUIRED IN THE PROJECT SHALL BECOME THE PROPERTY OF THE CONTRACTOR AND SHALL BE DISPOSED OF BY THE CONTRACTOR IN A MANNER ACCEPTABLE TO THE PROJECT MANAGER WITHOUT COST TO THE CITY. THE CONTRACTOR WILL BE REQUIRED TO OBTAIN AN EARTH CHANGE PERMIT IF ANY MATERIAL IS STORED ON THE PROJECT SITE AND/OR DISPOSED OF WITHIN THE CITY LIMITS.

18. ALL TREES, BRUSH AND OTHER DEBRIS THAT MIGHT INTERFERE WITH THE FLOW OF WATER IS TO BE CLEANED OUT TO THE RIGHT-OF-WAY LINE IN A MANNER APPROVED BY THE CITY OF TULSA. ALL COST TO BE INCLUDED IN THE PRICE BID FOR OTHER ITEMS OF WORK. TREES OUTSIDE THE FILL SLOPES AND THE TOP OF CUT SLOPES SHALL NOT BE DISTURBED EXCEPT WITH THE WRITTEN APPROVAL OF THE CITY OF TULSA.

19. WHERE MATERIALS ARE TRANSPORTED IN THE PROSECUTION OF WORK, VEHICLES SHALL NOT BE LOADED BEYOND THE CAPACITY RECOMMENDED BY THE VEHICLE MANUFACTURER OR AS PRESCRIBED BY ANY FEDERAL, STATE OR LOCAL LAW OR REGULATION.

20. ANY DAMAGE TO THE ROADWAY PAVEMENT, CURB, DRIVEWAYS OR SIDEWALK CAUSED BY THE CONTRACTOR'S OPERATION SHALL BE REPAIRED TO THE CITY OF TULSA'S SATISFACTION AND SHALL BE ACCOMPLISHED AT THE CONTRACTOR'S SOLE EXPENSE. CONTRACTOR SHALL EXERCISE GOOD JUDGEMENT WHEN PLANNING HAUL ROUTES IN AND OUT OF NEIGHBORHOODS OR ARTERIAL STREETS AS TO NOT TRANSVERSE ACROSS NEWLY PLACED PAVEMENT.

GENERAL CONSTRUCTION NOTES

21. IF THE CONTRACTOR ENCOUNTERS VOIDS WHEN PATCHING STREETS, THE CONTRACTOR SHALL CALL STREET MAINTENANCE AND INSPECTION AT 918-576-5514 FOR AN INSPECTION BEFORE PROCEEDING WITH WORK.

22. THE PROJECT SHALL BE CONSTRUCTED WITH CONTINUOUS FLOW OF MATERIAL SUPPLIED TO THE PROJECT SUCH THAT THE LAYDOWN MACHINE WILL REMAIN IN MOTION. ANY DELAY IN FORWARD PROGRESSION OF THE LAYDOWN MACHINE MAY REQUIRE A TRANSVERSE JOINT AS DIRECTED BY THE CITY OF TULSA.

23. NO FLY ASH IS ALLOWED TO BE USED ON THIS PROJECT.

24. PHYSICAL TESTING FOR QUALITY ASSURANCE SHALL BE FURNISHED BY THE CITY.

25. CONTRACTOR IS RESPONSIBLE FOR ALL NECESSARY QUALITY CONTROL TESTING TO ENSURE THAT PROJECT REQUIREMENTS ARE MET.

26. MASONRY STRUCTURES SHALL NOT BE CONSTRUCTED WITHIN THE STREET RIGHT-OF-WAY.

27. ALL CONCRETE CURB AND GUTTERS SHALL BE MONOLITHIC POURS. DOWELED-ON CURBS WILL NOT BE ALLOWED.

28. NO LIFTING HOLES WILL BE ALLOWED ON ANY REINFORCED CONCRETE PIPES OR REINFORCED CONCRETE BOXES.

29. SIDEWALK RAMP CONSTRUCTION SHALL COMPLY WITH THE CURRENT AMERICANS WITH DISABILITIES ACT STANDARDS. SIDEWALK RAMPS SHALL BE DIRECTIONALLY ORIENTATED AND SHALL ALIGN WITH THE RAMP ACROSS THE STREET. TRUNCATED DOMES SHALL BE PERPENDICULAR TO, AND IN LINE WITH THE CROSSWALK. ALL CROSSWALK MARKINGS SHALL BE CONTINENTAL STYLE OR FOR DESIGNATED SCHOOL ZONE CROSSING.

30. REFLECTORIZED SHEETING ON SIGNS AND BARRICADES SHALL BE OF A CUBIC PRISMATIC TYPE AND SHALL MEET THE SPECIFICATIONS ESTABLISHED FOR ASTM D 4956-01 TYPE IX RETROREFLECTIVE SHEETING. REFLECTORIZED SHEETING ON DRUMS AND TUBE CHANNELIZERS SHALL BE OF A HIGH-INTENSITY TYPE AND SHALL MEET THE SPECIFICATIONS ESTABLISHED FOR ASTM D 4956-01 TYPE III RETROREFLECTIVE SHEETING.

GENERAL CONSTRUCTION NOTES

31. CONTRACTOR SHALL SALVAGE ALL CAST IRON INLET GRATES, INLET FRAMES, MANHOLE COVERS, MANHOLE FRAMES, AND OTHER CASTINGS. SALVAGED CASTINGS SHALL BE DELIVERED TO THE METAL RECYCLE BINS IN THE STOCKROOM AREA AT THE UNDERGROUND COLLECTIONS BASE LOCATED AT 9319 E 42ND ST N BETWEEN THE HOURS OF 7:30 AM AND 3:00 PM MONDAY THROUGH FRIDAY. CONTRACTOR MUST OBTAIN A RECEIPT/TRIP TICKET WITH QUANTITY DELIVERED.

32. THE SIGN PLACEMENT STATIONING AND LOCATIONS SHOWN ON THE PLAN SHEETS AND SUMMARY SHEETS ARE APPROXIMATE. EXACT STATIONING AND LOCATIONS SHALL BE DETERMINED BY THE CONTRACTOR SO THAT THE SIGN IS INSTALLED IN ACCORDANCE WITH CITY OF TULSA STANDARDS, CURRENT AMERICANS WITH DISABILITIES ACT STANDARDS, AND THE MANUAL ON UNIFORM TRAFFIC CONTROL DEVICES IN ORDER TO PROVIDE OPTIMUM VISIBILITY TO THE ONCOMING/APPROACHING MOTORIST. IF A PROPOSED LOCATION CONFLICTS WITH OTHER SIGNS, UTILITIES, OR OTHER ROADWAY FEATURES, THE CITY OF TULSA SHALL BE NOTIFIED.

33. POST LENGTHS SHOWN ON SIGN SUMMARY ARE APPROXIMATE. EXACT LENGTHS SHALL BE DETERMINED BY A FIELD SURVEY CONDUCTED BY THE CONTRACTOR.

34. ALL ASPHALT STREETS THAT ARE TO BE RECONSTRUCTED SHALL BE LEFT WITH A DRIVABLE SURFACE AT ALL TIMES. THE CONTRACTOR WILL NOT BE ALLOWED TO MILL OFF ALL THE ASPHALT BEFORE EXCAVATION BEGINS.

35. THE CONTRACTOR SHALL REPLACE ANY SECTION CORNERS OR OTHER PERMANENT RIGHT OF WAY MARKERS REMOVED OR DISTURBED AS A RESULT OF THE CONSTRUCTION OF THIS PROJECT. REPLACEMENT OF SECTION CORNERS OR ANY OTHER MONUMENTS SHALL BE PERFORMED BY A LICENSED LAND SURVEYOR AUTHORIZED TO PERFORM WORK IN THE STATE OF OKLAHOMA.

36. THE CONTRACTOR SHALL BE RESPONSIBLE FOR THE CONTROL AND MAINTENANCE OF THE STORMWATER DRAINAGE. STORMWATER PONDING ON THE CONSTRUCTION SITE THAT IS THE RESULT OF CONSTRUCTION WILL NOT BE ALLOWED.

37. IT SHALL BE UNDERSTOOD THAT CONSTRUCTION SHALL BEGIN ON THE STREETS HIGHLIGHTED IN YELLOW AND MARKED AS STREET MAINTENANCE-NO PLANS ON PAGE PL-1 FIRST AND THEN ONCE ALL STREET MAINTENANCE CONSTRUCTION IS COMPLETE, CONTRACTOR MAY BEGIN ON STREETS HIGHLIGHTED IN PINK AND MARKED AS STREET REHABILITATION-PLANS (11" X 17") ON PAGE PL-1.

GENERAL CONSTRUCTION NOTES

38. ALL CONTRACT SUBMITTALS SHALL BE SUBMITTED TO CITY OF TULSA CONSTRUCTION INSPECTOR MANAGER AND APPROVED BEFORE WORK MAY BEGIN.

39. ALL DETAILED COST BREAKDOWNS AND SUBMITTALS FOR ANY UNFORESEEN SPECIAL CONSTRUCTION ITEMS SHALL BE SUBMITTED TO THE CITY OF TULSA CONSTRUCTION INSPECTOR MANAGER AND WRITTEN APPROVAL RECEIVED BEFORE WORK MAY BEGIN.

40. THE CONTRACTOR SHALL HAVE A SIGNED RIGHT-OF-ENTRY FORM FROM PROPERTY OWNER PRIOR TO ANY WORK ADJACENT TO A WALL, FENCE OR OTHER STRUCTURE THAT MAY BE SUBJECT TO COLLAPSE DURING CONSTRUCTION OPERATIONS.

41. THE CONTRACTOR SHALL BE RESPONSIBLE FOR ENSURING THEIR FIELD PERSONNEL RESPONSIBLE FOR WORK BEING PERFORMED UNDER THIS CONTRACT ARE FAMILIAR WITH THE CITY OF TULSA AND ODOT SPECIFICATIONS.

42. PRIOR TO THIS CONTRACT BEING DEEMED SUBSTANTIALLY COMPLETE. THE CONTRACTOR WILL BE RESPONSIBLE FOR SUBMITTING A PREFERRED WALKTHROUGH DATE. IF A PREFERRED DATE HAS NOT BEEN SUBMITTED WITHIN 10 CALENDAR DAYS OF THE CITY OF TULSA DECLARING THE PROJECT SUBSTANTIALLY COMPLETE, ONE WILL BE DESIGNATED BY THE CITY OF TULSA. IF THE PUNCH LIST IS NOT COMPLETE WITHIN 10 WORKDAYS, CONTRACT TIME WILL RESUME.

43. COMMUNICATION BETWEEN THE CITY OF TULSA AND THE CONTRACTOR IS OF THE UTMOST IMPORTANCE DURING THE DURATION OF THIS CONTRACT. IT IS IMPERITIVE THAT THE CONTRACTOR PROVIDES THE REQUIRED CONTRACT SCHEDULE AND PAVING PLANS TO ALLOW THE CITY OF TULSA TO SCHEDULE ANY REQUIRED TESTING WITH THEIR TESTING COMPANIES AND TO PREVENT ANY DELAYS IN WORK BY THE CONTRACTOR. ANY WRITTEN CORRESPONDENCES BETWEEN THE CITY OF TULSA AND THE CONTRACTOR SHALL BE COPIED TO THE DESIGNATED INSPECTOR AND CONSTRUCTION INSPECTOR MANAGER.

44. THE CONTRACTOR SHALL SUPPLY TO THE CITY OF TULSA ANY CALIBRATION DATA NECESSARY TO SUBSTANTIATE THAT THE EQUIPMENT USED DURING THE CONSTRUCTION PROCESS, MEETS THE REQUIRED APPLICATION SPECIFICATIONS.

GENERAL CONSTRUCTION NOTES

45. THE CONTRACTOR SHALL NOTIFY THE CITY OF TULSA IN WRITING OF ANY UNFORESEEN ISSUES THAT MAY ARISE DURING CONSTRUCTION. THE CONTRACTOR IS RESPONSIBLE FOR NOTIFYING ANY UTILITY, COMPANIES OR CITIZENS FOR WHOM THE DAMAGES AFFECT.

46. CONTRACTOR SHALL NOT HAVE MORE THAN ONE HALF OF A MILE OF ARTERIAL STREET SHUT DOWN FOR CONSTRUCTION AT ONE TIME WITHOUT WRITTEN APPROVAL FROM THE CITY OF TULSA.

ITEM	SPEC NUMBER	ITEM DESCRIPTION	UNIT	QUANTITY	PAY ITEM NOTES
1	202(A)	UNCLASSIFIED EXCAVATION	CY	800	2,10,12,40,47
2	230(A)	SOLID SLAB SODDING	SY	500	13,14,15
3	303(A)	AGGREGATE BASE TYPE A	CY	800	2,3,4
4	310(B)	SUBGRADE METHOD B	SY	500	2,19
5	325	SEPARATOR FABRIC	SY	900	8,10,19
6	409	FABRIC REINFORCEMENT(GP-25)	SY	45,000	8,10,19
7	411(S4)	ASPHALT CONCRETE, TYPE S4 (PG 64+22) (2" THICKNESS)	TON	5,000	10,12,16,17,18,19,21,45,48
8	411(D)(SP)	TYPE "S5" ASPHALT CONCRETE(1" LEVEL-UP)	TON	1	10,12,16,17,18,19,21,48
9	412	COLD MILLING PAVEMENT (2" THICKNESS)	SY	45,000	6,10,12,21,47,48
10	609(A)	REMOVE AND REPLACE 6" CONCRETE CURB	LF	1	3,4,10,19,20,21,22,23
11	609(B)	REMOVE AND REPLACE 6" CONCRETE CURB AND GUTTER	LF	500	3,4,10,19,20,21,22,23
12	610(A)	4" CONCRETE SIDEWALK	SY	3400	7,19,20,21,23,24,25
13	610(B)	REMOVE AND REPLACE 6" HES PCC DRIVEWAY	SY	2200	3,4,7,10,19,20,21,23,24,25
14	610(SP)	CURB RAMP	EA	10	10,19,20,21,23,50
15	610(I)	TACTILE WARNING DEVICE	SF	90	19
16	612(A)	ADJUST MANHOLE TO GRADE	EA	10	10,19,21,23,26,27,28,48
17	612(C)	ADJUST INLETS TO GRADE	EA	10	10,12,19,21,23,26,27,28,31,33,34,48
18	612(E)	ADJUST VALVE BOXES TO GRADE	EA	10	10,19,21,23,26,27,28,48
19	619(B)	REMOVAL OF SIDEWALK	SY	3400	10,19,21
20	641	MOBILIZATION	EA	1	
21	855(A)	TRAFFIC STRIPE(PLASTIC)(4"WIDE)	LF	1	36,52
22	855(B)	TRAFFIC STRIPE(PLASTIC)(ARROW)	EA	1	36
23	855(B)	BIKE LANE SYMBOL(GREEN BACKGROUND)(PRE-FORMED)	EA	1	36
24	855(B)	BICYCLE SYMBOL WITH SHARROW(WHITE)	EA	1	36
25	855(B)	BICYCLE SYMBOL(NO SHARROW)(WHITE)	EA	1	36
26	COT202	QUICK SET FLOWABLE FILL	CY	5	10,19
27	COT 335	CONTRACTOR'S QUALITY CONTROL	LSUM	1	
28	880(B)	TRAFFIC CONTROL	LSUM	1	37,38,39
29	SPECIAL	PRE-FORMED BIKE LANE MARKINGS (24"WIDE)(BLM-1)	LF	1	36
30	SPECIAL	JOINT SEAL(SILICONE)	LF	10	
31	SPECIAL	TYPE I AC PATCH WITH TYPE S3 (PG 64+22 OK)	CY	65	3,4,9,10,12,16,17,18,19,21,48
32	SPECIAL	TYPE I PCC PATCH	CY	10	3,4,9,10,19,20,21,23,48,49
33	SPECIAL	URBAN RIGHT-OF-WAY RESTORATION	EA	1	2,3,11,19,33
34	SPECIAL	CROSS STREET DRAINS HES PCC	CY	5	10,11,12,19,21,29,47
35	SPECIAL	MULTI-AXIAL COMPOSITE PAVING GRID(MCPG-1-7)	SY	1	10,19
		OWNER ALLOWANCE	ALLOW	10000	



City of Tulsa
A New Kind of Energy.

PROJECT QUANTITIES
NON-ARTERIAL MILL, PATCH & OVERLAY
Maintenance Zone 6042
2026-MPO C3
PQ-1

